

1954

Cuprous Oxide as a Catalyst. II. Adsorption by Cuprous Oxide

R. C. Brown
Iowa State College

R. C. Peabody
Iowa State College

Copyright © Copyright 1954 by the Iowa Academy of Science, Inc.
Follow this and additional works at: <https://scholarworks.uni.edu/pias>

Recommended Citation

Brown, R. C. and Peabody, R. C. (1954) "Cuprous Oxide as a Catalyst. II. Adsorption by Cuprous Oxide," *Proceedings of the Iowa Academy of Science*: Vol. 61: No. 1 , Article 27.
Available at: <https://scholarworks.uni.edu/pias/vol61/iss1/27>

This Research is brought to you for free and open access by UNI ScholarWorks. It has been accepted for inclusion in Proceedings of the Iowa Academy of Science by an authorized editor of UNI ScholarWorks. For more information, please contact scholarworks@uni.edu.

Cuprous Oxide as a Catalyst. II. Adsorption by Cuprous Oxide¹

By R. C. BROWN AND R. C. PEABODY²

In a previous paper³, data were presented which demonstrated that cuprous oxide, prepared by the glucose reduction of a cupric nitrate solution at temperatures below 85°, was an active catalyst for the hydrogenation of furfural to furfuryl alcohol. It was also shown that the cuprous oxide was promoted by the addition of calcium oxide and vanadium tetroxide. The most active mixture contained these oxides in the ratio $\text{Cu}_2\text{O}:\text{V}_2\text{O}_4:\text{CaO}::1.0:0.71:1.4$. In order to elucidate the role played by the catalyst in the hydrogenation of furfural, the absorptive capacity of the catalyst for furfural and furfuryl alcohol was investigated. Previous work by Stanerson⁴ had shown that the catalyst would adsorb hydrogen in an irreversible manner at temperatures above 56° C. The authors found that the adsorption of hydrogen may be complicated by reduction of the cuprous oxide component of the catalyst to metallic copper.

EXPERIMENTAL

Preparation of Catalysts.

(1) Cu_2O . — One thousand and eighty-five grams each of $\text{Cu}(\text{NO}_3)_2 \cdot 3\text{H}_2\text{O}$ and dextrose was dissolved in 5425 ml. of water. To this mixture was added 1736 ml. of 40% NaOH solution. The precipitate was digested at 65-70° for 45 minutes and then filtered with suction. After washing with distilled water until the precipitate peptized and began passing through the filter paper, the precipitate was dried in a vacuum desiccator over Anhydron. The yield was 328.4 g. of Cu_2O or 102% of the theoretical. A yield greater than 100% is indicative of an impure preparation.

(2) V_2O_4 —Three hundred grams of V_2O_5 was added to a solution containing 300 g. of dextrose in 1500 ml. of water and the mixture was digested on a hot plate for 24 hours. The mixture was then filtered with suction and the precipitate was washed

¹Abstracted in part from the thesis presented by R. C. Peabody to the Graduate Faculty of Iowa State College in partial fulfillment of the requirements for the degree of Doctor of Philosophy.

²Deceased.

³Brown, Menzel, Stewart and Lafrancois, J. Am. Chem. Soc., 72, 5602 (1950)

⁴Stanerson, Ph. D. Thesis, Iowa State College, 1939.

with hot water until it peptized. The precipitate was then dried at 110° over night. The resulting hard blue lumps were powdered in a mortar to pass a 40 mesh sieve and then dried in a vacuum desiccator over Anhydrone. The yield was 289.5 g. V_2O_4 or 106% of the theoretical. Again, a yield greater than 100% is indicative of an impure preparation.

(3) *CaO*.—Five pounds of reagent grade calcium oxide was ignited in a muffle furnace at 900° for one hour and then placed in a screw-capped bottle while still very hot. After the solid had cooled to room temperature, the cap on the bottle was opened to the air momentarily to regain atmospheric pressure. Thereafter, the bottle was kept tightly sealed when not in use.

Determination of Catalytic Activity.—To determine the catalytic activity of the above preparations, an hydrogenation of furfural was carried out in the O.495-1. bomb following the procedure given in reference 3. The catalyst was prepared from 0.70 g. Cu_2O , 0.70 g. V_2O_4 and 0.525 g. *CaO*. The results are shown in Figure 1 where a curve taken from Figure 3 of reference 3 is given for the sake of comparison. It will be seen that, while the reaction with the present catalyst is characterized by a greater induction period, the catalyst is certainly as active as those reported in reference 3.

Analysis of Catalyst Preparations.

(1) *Analysis of Cu_2O* .—In reference 3, it is reported that the Cu_2O analyzed 3.76% H_2O , 2.12% *Cu* and 94.12% Cu_2O . However, the method used in that analysis is incapable of distinguishing between Cu_2O and *CuO*. The "silver sulfate-sulfuric" method of Fitzpatrick⁵ was found to give inconsistent results. On the other hand, the method of Ubaldini and Guerrieri⁶ seems to be satisfactory. According to this method, the cuprous oxide preparation analyzed 2.2% *Cu*, 64.1% Cu_2O , 26.4% *CuO* and 7.3% unaccounted for. This material will hereafter be referred to as Cu_2O .

(2) *Analysis of V_2O_4* .—In reference 3, it is stated that it is unlikely that V_2O_5 is completely reduced to V_2O_4 , or remains completely anhydrous. However the preparation had not previously been analyzed. As a first attempt at analysis, samples of the preparation were dissolved according to the method of Prandtl and Murschhauser⁷, and the pentavalent vanadium content of the resulting solution was determined by the procedure recommended

⁵Fitzpatrick in Scott, "Standard Methods of Chemical Analysis", 5th Edition, Vol. I, D. Van Nostrand Co., Inc., New York, N. Y., 1939, p. 394.

⁶Ubaldini and Guerrieri, *Ann. chim. applicata*, 38, 695 (1948).

⁷Prandtl and Murschhauser, *z. anorg. Chem.*, 56, 173 (1907).

by Ramsey⁸. However, the results given by this method were found to be unsatisfactory. On the other hand, the method of Morette and Gaudfroy⁹ was found to give consistent results. According

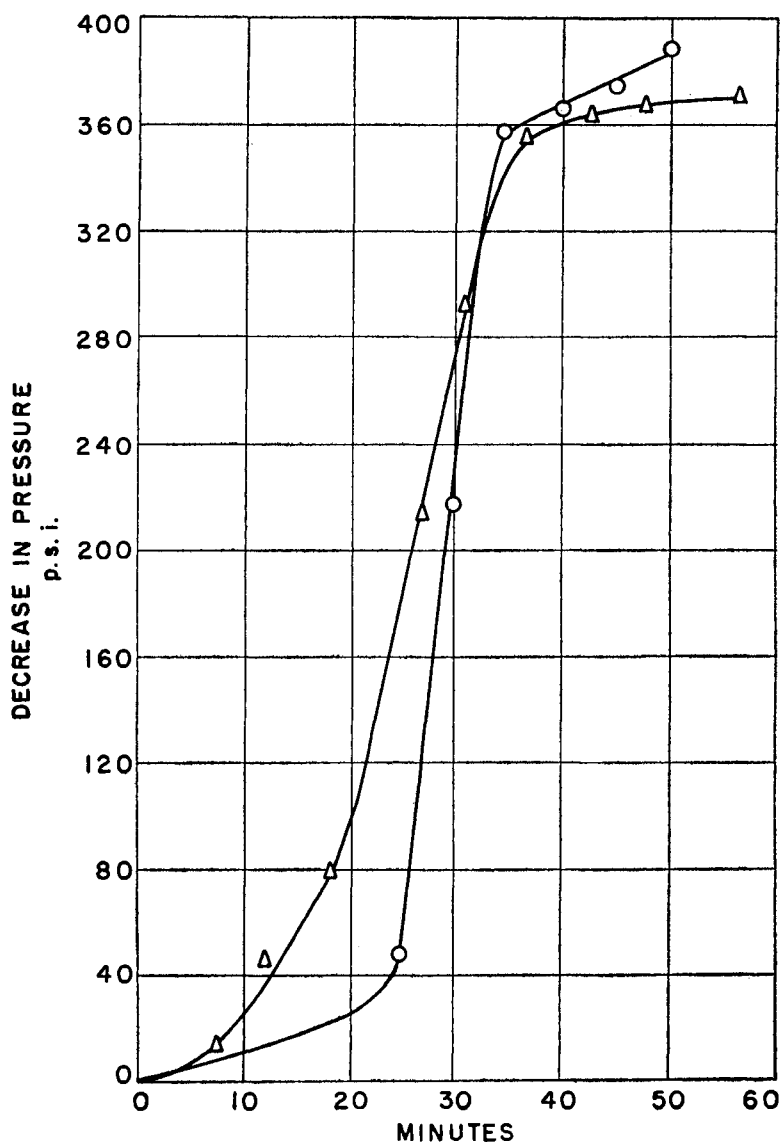

Fig. 1. Determination of Catalytic Activity

Key: Δ Curve taken from Fig. 3 of Reference 3

O Data obtained in the present investigation

⁸Ramsey, *THIS JOURNAL*, 49, 1138 (1927).

⁹Morette and Gaudfroy, *Bull. soc. chim. France*, 1951, 73.

to this method, the vanadium tetroxide preparation analyzed 44.1% V_2O_4 , 48.2% V_2O_5 and 7.7% unaccounted for. This material will hereafter be referred to as V_2O_4 .

(3) *Analysis of CaO.*—The total calcium content of the calcium oxide preparation was determined by an adaption of a method used to determine total hardness in water¹⁰. A series of such determinations gave, as an average, 69.84% Ca. Pure CaO contains 71.47% Ca. This material will hereafter be referred to as CaO.

Adsorption of Furfural.

(1) *Apparatus.*—The apparatus used in studying the adsorption of furfural was designed as a modification of the familiar Abderhalden drying pistol. The apparatus is shown in Figure 2. Flask A contained a liquid which was refluxed. The vapors of this liquid pass through the jacket and enter a condenser placed in the standard taper B. The vapors are condensed and the liquid is returned to flask A by means of the tube C. In this manner, the inner chamber D is maintained at a temperature close to the boiling point of the liquid placed in flask A. The temperature in the inner chamber D was measured by means of a pair of thermocouples inserted in the thermocouple wells E and F.

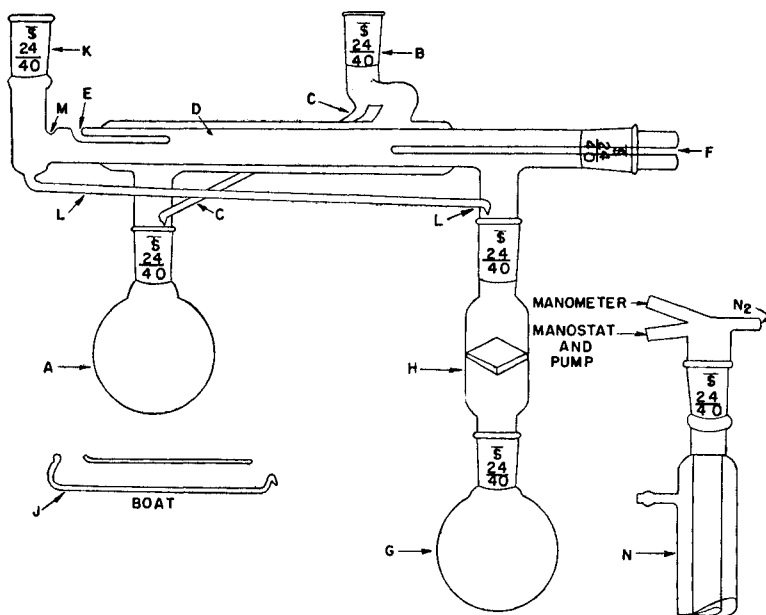

Figure 2 Adsorption Apparatus

¹⁰Diehl, Goetz and Hach, *J. Am. Water Works Assoc.*, 42, 40 (1950).

Flask G contained furfural. When brought to boiling, the furfural vapors passed through the Iowa State type Kjeldahl trap H which caught any liquid furfural which might have bumped up into the trap. The furfural vapors then entered the inner chamber D and passed over the boat J which contained the catalyst sample under study. The vapors of furfural then entered a condenser N placed in the standard taper K. The vapors were then condensed and returned to flask G by means of the tube L. The condensed furfural was prevented from running back into the inner chamber D by means of a crease M in the glass. It was found advisable to place a ring of asbestos paper around the neck of flask A to prevent overheating of the tube L by the burner under flask A.

In the top of the condenser N was placed a Y joint which was connected with a manometer, a N₂ tank and Cartesian manostat and water aspirator or vacuum pump. The liquid placed in flask A was chosen according to its boiling point and stability on refluxing so that the inner chamber D would be maintained at a temperature above the boiling point of furfural at the pressure being used.

(2) *Procedure*.—The procedure used was to place a weighed sample of the catalyst in the boat J, which was then placed in the inner chamber D. The system was evacuated and then filled with tank N₂. Freshly distilled furfural was placed in flask G and a suitable liquid introduced into flask A. Boiling stones were also placed in flask A to facilitate boiling. Considerable difficulty was experienced with bumping of the furfural, particularly at pressures below atmospheric. The use of boiling stones and wooden applicator sticks failed to prevent bumping. Packing the flask with glass wool also failed as the introduction of a fine stream of N₂ bubbles. This difficulty was finally overcome by the use of an ebullator tube of the type recommended by Matviak¹¹.

The pump was then turned on and when the pressure had reached the desired value, as read on the manometer, the Cartesian manostat was set to maintain the pressure. The liquid in flask A was then boiled. When the temperature of the inner chamber had become constant, the furfural in flask G was heated to boiling and furfural vapors passed over the catalyst for some definite period of time, usually an hour. The burner under flask G was then removed. When liquid furfural stopped flowing from the end of tube L, the burner under flask A was removed. When

¹¹Matviak, *Chemist-Analyst*, 40, 3, 64 (1951).

the system had cooled to room temperature, it was brought to atmospheric pressure with N_2 and the pump turned off.

The boat was then removed from the chamber D by means of a length of wire with a hook on one end which engaged a hook on one end of the boat. The boat was then weighed any change in weight was recorded. The boat was then reintroduced into the chamber and the procedure repeated.

(3) *Adsorption Studies*.—The first adsorption study on furfural was made at atmospheric pressure. A sample of the catalyst was prepared from 1.0 g. Cu_2O , 0.70 g. V_2O_4 and 1.40 g. CaO . This particular combination of Cu_2O , V_2O_4 and CaO was used in all the adsorption studies. The weight of sample taken was 3.077 g. The boat was placed in the adsorption apparatus and benzaldehyde (b.p. = 179°) was placed in flask A. When the temperature of the inner chamber had reached 179° , the burner under flask G was turned on. By this time, it was observed that the catalyst had turned black. The usual color of the mixture is dull red. When the furfural vapor entered the adsorption chamber, it condensed to a liquid. While most of this liquid later evaporated, a film of liquid remained between the wall of the boat and the wall of the adsorption chamber. For this reason, the boat was not weighed after removal from the chamber.

The change in color of the catalyst on heating may be due to disproportionation of the Cu_2O present into Cu and CuO . To test this hypothesis, another sample of the catalyst was prepared and divided into two portions. One portion was analyzed for metallic copper content and the other portion placed in the adsorption apparatus and heated by refluxing methyl benzoate (b. p. = 198°) for one hour. Again the sample turned black. The system was then cooled in N_2 and analyzed for metallic copper content. It was found that on heating to 190° , the sample, which weighed 1.645 g., lost 0.030 g. in weight or 1.82%. The portion which had not been heated analyzed 3.40% metallic copper while the portion which had been heated to 190° analyzed 3.53% metallic copper. Thus, little, if any, disproportionation of cuprous oxide occurred on heating the catalyst to 190° in an atmosphere of N_2 . The loss in weight is probably due to loss of water and the darkening of the catalyst may be due to either pyrolysis of organic matter undoubtedly present or to change in the particle size of the catalyst.

Before any further study of the ability of the catalyst to adsorb furfural could be made, it was necessary to know whether the

catalyst which had been heated to 190° and turned black was still catalytically active. Accordingly, a sample of the catalyst was prepared from 0.70 g. Cu_2O , 0.70 g. V_2O_4 and 0.525 g. CaO . This sample was placed in the boat and heated in N_2 to 190° for 3 hours. The sample taken weighed 1.828 g. and lost 0.093 g. or 5.08% by weight on heating. This sample was used to hydrogenate furfural. The results are shown in Fig. 3, where the previous hydrogenation run on the unheated catalyst is also given. A comparison of the two curves shows that the catalyst which had been heated to 190° for 3 hours was catalytically active.

In Fig. 3, curve 1 presents the data obtained using an unheated sample of the catalyst. This curve is plotted in greater detail than

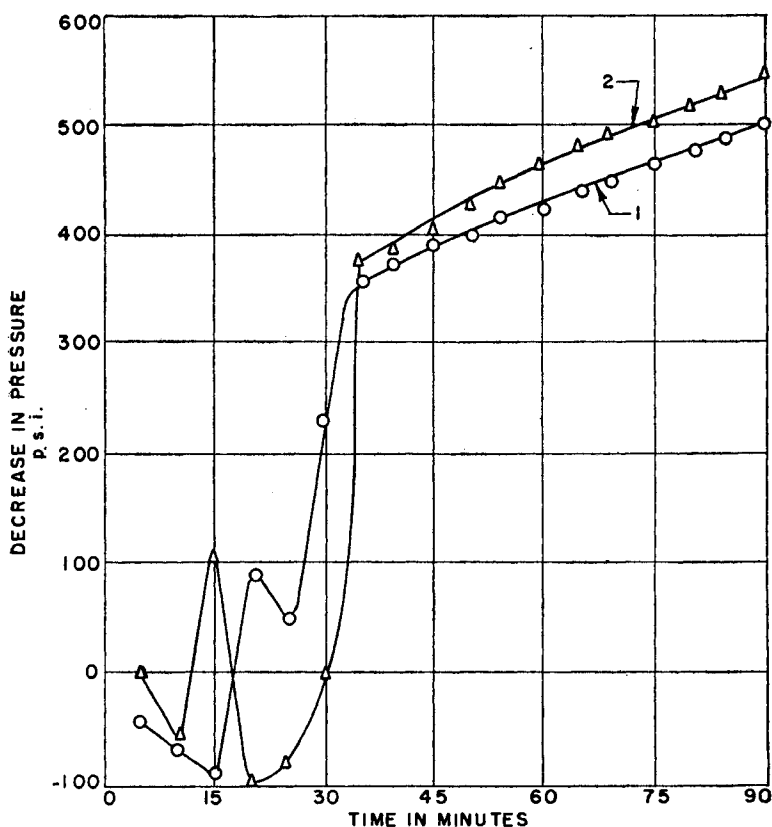

Figure 3.
Curve 1, hydrogenation with unheated catalyst
Curve 2, hydrogenation with heated catalyst

in Fig. 1. It will be noted that between 5 and 15 minutes, the pressure in the bomb increased 93 p. s. i. while the temperature

increased from 26° to 73°. Between 15 and 20 minutes, the pressure decreased 183 p. s. i. while the temperature increased from 73° to 100°. Between 20 and 25 minutes, the pressure increased 38 p. s. i. while the temperature increased from 100° to 115°. Thereafter, a smooth decrease in pressure due to reaction followed. Curve 2, Fig. 3, presents the data obtained using the heated sample of the catalyst. Between 5 and 10 minutes, the pressure increased 59 p. s. i. while the temperature increased from 23° to 32°. Between 10 and 15 minutes, the pressure decreased 169 p. s. i. while the temperature increased from 32° to 58°. Between 15 and 20 minutes, the pressure increased 210 p. s. i. while the temperature increased from 58° to 87°. Thereafter, a smooth decrease in pressure due to reaction followed.

Another sample of catalyst was prepared in the ratio used for adsorption studies. The weight of sample taken was 3.074 g. The sample was heated at 190° to constant weight. The sample lost 0.085 g. or 2.78% by weight. This sample was then used to determine the isothermal adsorption characteristics of the catalyst toward furfural vapor at 190° and atmospheric pressure. The results are shown in Fig. 4 where the increase in weight of the catalyst is plotted against the time the catalyst was exposed to furfural vapor.

Since the rate of adsorption was becoming erratic and more

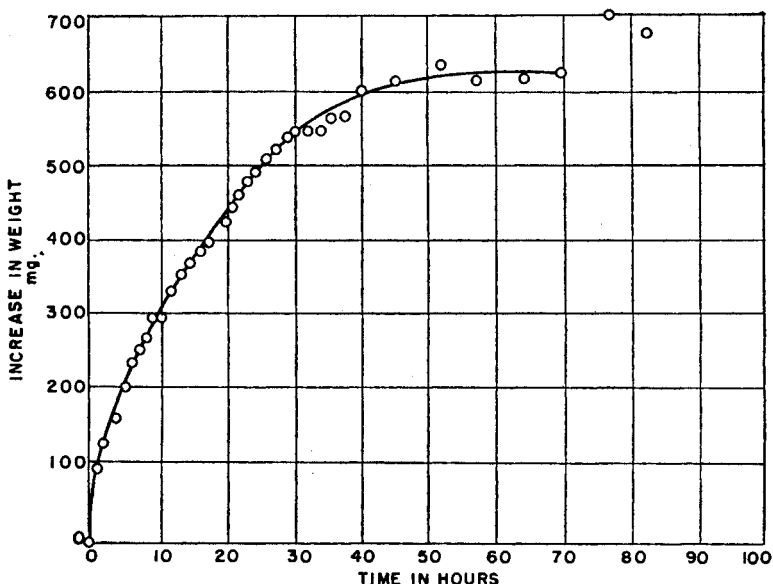

Figure 4. Adsorption of furfural vapor

particularly because some of the catalyst was being mechanically transferred by the furfural vapor on past the boat, this run was stopped. The color of catalyst after adsorption of furfural vapor was a light brown and it was still very powdery. No evidence of the formation of a gummy polymer was noted. Some of the furfural decomposed on the walls of the adsorption chamber and on the sides of the boat leaving a dark deposit.

If an Elovich plot of the data is made, as outlined by Taylor and Thon¹², a straight line is obtained (Fig. 5) if t_0 is taken as 20. ∞ then has a value of 1.96 and a , the initial rate of adsorption is 25.5 mg. of furfural per hour. The value of qt_0 is 90 mg., which according to Taylor and Thon, can be taken to represent the amount of an initial massive adsorption. However, the experimentally measured amount of furfural adsorbed over the first hour was only 86 mg. Thus, if the use qt_0 as a measure of an instantaneous massive adsorption is valid, no increase in adsorption occurred until more than one hour later. Incidentally, t_0 need not be found as a result of trial and error¹³, if one selects any two points on the original plot of q vs. t , say q_1, t_1 and q_2, t_2 , a third point, q_3, t_3 , is chosen such that $q_3 = \frac{1}{2}(q_1 + q_2)$ and the corres-

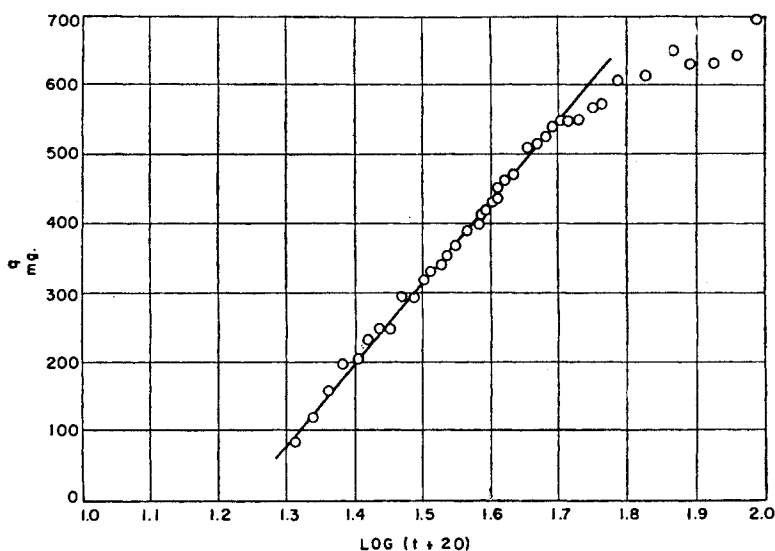

Fig. 5. Elovich plot of the data shown in Fig. 4. t is in hours and q is in milligrams.

¹²Taylor and Thon, *J. Am. Chem. Soc.*, 74, 4169 (1952).

¹³Johnson, "Nomography and Empirical Equations", John Wiley and Sons, Inc., New York, N. Y., 1952, p. 120.

ponding value of t_3 is read from the plot. All three points lie on the curve, hence:

$$q_1 = \frac{2.3}{\infty} \log(t_1 + t_0) - \frac{2.3}{\infty} \log t_0$$

$$q_2 = \frac{2.3}{\infty} \log(t_2 + t_0) - \frac{2.3}{\infty} \log t_0$$

$$q_3 = \frac{2.3}{\infty} \log(t_3 + t_0) - \frac{2.3}{\infty} \log t_0$$

Substituting $q_3 = \frac{1}{2}(q_1 + q_2)$, we have:

$$\log(t_3 + t_0) = \frac{1}{2}[\log(t_1 + t_0) + \log(t_2 + t_0)]$$

$$\text{or, } t_3 + t_0 = \sqrt{(t_1 + t_0)(t_2 + t_0)}, \text{ whence,}$$

$$t_0 = \frac{t_1 t_2 - t_3^2}{2t_3 - t_1 - t_2}$$

The most promising method of analyzing the resulting mixture of catalyst and absorbed furfural appeared to be that of Maaskant¹⁴. According to this method, furfural may be quantitatively precipitated from its aqueous solution by means of an acetic acid solution of p-nitrophenylhydrazine. It was felt that the adsorbed furfural could best be removed from the catalyst by extraction with anhydrous ether.

In order to test this method of separation and analysis, several synthetic mixtures were prepared by treating a sample of the catalyst with a known weight of doubly-distilled furfural. The method finally evolved was as follows: the mixture of catalyst and furfural was placed in a Soxhlet extraction thimble and extracted with anhydrous ether for at least 24 hours. At the end of this period, 50 ml. of distilled water was added to the ether extract and a Y-joint attached to the flask. The Y-joint was connected to a N₂ tank, a manometer and a water pump. The ether layer was then evaporated at room temperature under reduced pressure. When all the ether had been removed, the flask was filled with N₂. The aqueous furfural solution left in the flask was made 30% in acetic acid, poured into a beaker and the flask was rinsed with 30% acetic acid.

A solution containing twice the theoretical amount of p-nitrophenylhydrazine in 30% acetic acid was then prepared and added to the furfural solution. This mixture was allowed to stand overnight and then the resulting precipitate was filtered, washed with

¹⁴Maaskant, *Rec. trav. chim.*, 55, 1068 (1936).

30% acetic acid and then with water. The filtering crucible containing the precipitate was then placed in a vacuum desiccator until it reached constant weight. By this procedure, 94% of the furfural added to the synthetic mixtures was found during the analysis. This procedure was then used on the sample of catalyst which had been allowed to adsorb furfural vapors at 190° and atmospheric pressure. After 48 hours of continuous extraction with anhydrous ether, the sample of catalyst had lost an amount in weight which corresponded to a removal of 21.1% of the adsorbed furfural. On the addition of a solution of 0.770 g. of p-nitrophenylhydrazine in 50 ml. of 30% acetic acid to the aqueous furfural solution, a precipitate was obtained which weighed only 0.023 g., which corresponded to a recovery of only 1.3% of the adsorbed furfural. The precipitate was red-brown in color and melted at 195-200° C. The precipitate was recrystallized from hot ethanol, and then had a melting point of 203-210° C. The melting point of the p-nitrophenylhydrazone of furfural is 154°, while that of p-nitrophenylhydrazone is 157° C. Thus the material removed from the catalyst which had been exposed to furfural vapor at 190° was not furfural.

It is possible that furfural in contact with the catalyst might be changed to either furoin or furil. Some furoin and furil were obtained from Eastman, Kodak Co. and the corresponding p-nitrophenylhydrazones were prepared according to the directions given by McElvain.¹⁵

A 1×10^{-4} or 0.0001 molar solution of p-nitrophenylhydrazine in 95% ethanol was prepared in a 50 ml. volumetric flask. Solutions in 95% ethanol of the p-nitrophenylhydrazones of furfural, furoin, furil and the ether extracted material were prepared so that they had about the same intensity of color as the p-nitrophenylhydrazine solution. The four solutions of the known compounds all appeared yellow, while the unknown solution was different, having a distinct pink tinge in addition to a yellow color. These five solutions were then spectrophotometrically examined using a Cary recording spectrophotometer and 2 cm. cells over the wave length range 225-880 millimicrons. The resulting spectral distribution curves are shown in Fig. 6. It can be seen from Fig. 6 that the material extracted from the catalyst is definitely neither furfural, furoin nor furil.

Since the adsorption of furfural vapor by the catalyst at 190° C. is apparently an irreversible process, a series of experiments was carried out to determine at what temperature reversible adsorption

¹⁵McElvain, "The Characterization of Organic Compounds," The Macmillan Co., New York, N.Y., 1946, p. 199.

of furfural will occur. The procedure used was to prepare a sample of the catalyst in the usual proportions, which was placed in a tared bulb and weighed. The bulb was then placed in a flask of methyl benzoate and evacuated twice, each time being filled with N_2 . The bulb was then heated by refluxing methyl benzoate to constant weight. On cooling, the catalyst was protected by a tube containing Ascarite and Anhydrene.

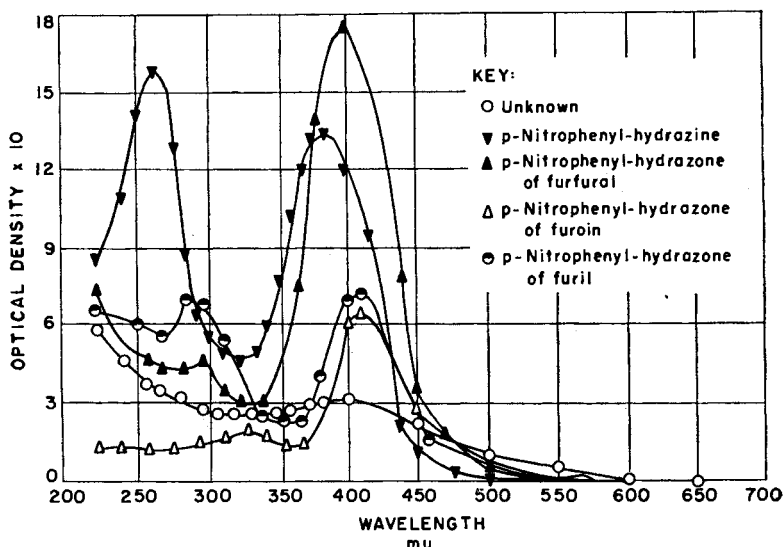

Fig. 6 Spectral distribution curves.

By means of a long capillary pipette, a known weight of freshly distilled furfural was added to the catalyst and mixed by rotating the bulb. The bulb was then allowed to stand at some fixed temperature, surrounded by some appropriate refluxing liquid, for 3 hours; at the end of which time the system was evacuated with an oil pump, the bulb being maintained at the same temperature. After one hour of pumping, the bulb was cooled in a N_2 atmosphere and then weighed. This was repeated until the bulb reached constant weight. The results are shown in the following table.

| Wt. of furfural added | Liquid surrounding bulb | Temp. of refluxing liquid | No. of hours of pumping | % furfural removed by pumping |
|-----------------------|-------------------------|---------------------------|-------------------------|-------------------------------|
| 0.935 g. | air | 22° C. | 22 | 100.0% |
| 0.711 g. | acetone | 55° C. | 9 | 100.0% |
| 0.643 g. | water | 100° C. | 2 | 100.0% |
| 0.880 g. | n-amyl acetate | 146° C. | 6 | 97.5% |
| 0.689 g. | methyl benzoate | 190° C. | 4 | 99.4% |

Thus the adsorption of furfural appears to be essentially reversible at temperatures up to 190°. Next a series of experiments was carried out to determine the adsorptive characteristics of the catalyst for furfural at a pressure of 80 mm. and various temperatures. The apparatus and procedure used have already been described. The results are presented in the following table.

| Wt. of catalyst used | Liquid in flask A | Temperature of adsorption chamber | Time of experiment | Increase in weight of catalyst |
|----------------------|-----------------------|-----------------------------------|--------------------|--------------------------------|
| 2.930 g. | water | 100° C. | 23 hours | 0.000 g. |
| 2.900 g. | xylene | 136° C. | 20 hours | 0.000 g. |
| 2.900 g. | bromobenzene | 156° C. | 6 hours | 0.000 g. |
| 2.847 g. | n-butyl n-butyrate | 166° C. | 11 hours | 0.000 g. |
| 2.847 g. | p-cresyl methyl ether | 176° C. | 6 hours | 0.000 g. |
| 2.860 g. | methyl benzoate | 190° C. | 12 hours | 0.175 g. |

Adsorption of Furfuryl Alcohol.

(1) *Apparatus.*—The apparatus used was the same as that used in studying the adsorption of furfural (see Fig. 2).

(2) *Procedure.*—The procedure used was also the same as that used in studying the adsorption of furfural.

(3) *Adsorption Studies.*—The first adsorption study of furfuryl alcohol was made at 190° and atmospheric pressure. The liquid in flask A was methyl benzoate. A sample of the catalyst in the usual proportions was prepared which weighed 2.650 g. The furfuryl alcohol used was obtained from the Paragon Testing Laboratories and was freshly distilled, the first and last portions of the distillate being discarded. The freshly distilled furfuryl alcohol was water white, but it slowly developed a yellow tinge on standing.

Furfuryl alcohol vapor was passed over the catalyst for 11 hours at 190°. At the end of this time, the catalyst had turned a light tan color and had swollen to several times its original volume, so that it completely clogged the boat. It was found that the catalyst had increased in weight 2.310 g. This relatively enormous increase in weight is indicative of some process other than adsorption.

Dunlop and Peters¹⁶ reported that when furfuryl alcohol is heated, intermolecular dehydration occurs according to the scheme:

¹⁶Dunlop and Peters, *Ind. Eng. Chem.*, 34, 814 (1942).

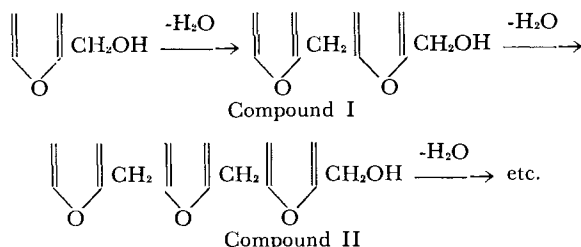

They found that after only 3 hours at 200°, some 20% of the furfuryl alcohol originally present was converted to compound I. Compound I was found to be insoluble in water, soluble in acetone, benzene and nitrobenzene. The α -naphthylurethan derivative of compound I melts at 107-8°. Compound II exhibited the same solubility characteristics as compound I. However, a Schotten-Baumann test on compound II was unsuccessful.

Thus, the large increase in weight on passing furfuryl alcohol over the catalyst may be due to such an intermolecular dehydration. Furfuryl alcohol is soluble in both acetone and benzene, but benzene was chosen as the solvent with which to extract the catalyst, because part of the vanadium component of the catalyst is soluble in acetone⁹ and nitrobenzene has a high boiling point (211°) and it was considered undesirable to subject the mixture to any further heating. Thus any unchanged adsorbed furfuryl alcohol as well as any compound I and II present could be separated from the catalyst by benzene extraction. The furfuryl alcohol could then be separated from any compound I or II by taking advantage of the solubility of furfuryl alcohol in water and the insolubility of compounds I and II in water.

The catalyst was therefore transferred to a Soxhlet thimble and extracted with benzene until the extract was colorless, which took about 40 minutes. The benzene extract was red-orange in color. The benzene remaining on the catalyst after extraction was removed by placing the thimble in a beaker and placing both in a drying oven at 110°. On cooling in air, a thick yellow-green smoke poured out of the thimble, the catalyst turned jet-black and glowed with burning embers. Enough heat was developed to char the thimble. Of course, it was now useless to weigh the thimble, so the amount of material removed from the catalyst by benzene extraction is unknown.

The benzene extract was subjected to distillation at atmospheric pressure to remove benzene. A small amount of a dark liquid remained behind. This was poured into a 25 ml. buret and the

flask was rinsed with 10 ml. of water which was added to the buret. The mixture was shaken and allowed to stand until it separated into two layers. Deriaz, Stacey, Teece and Wiggins¹⁷ reported that furfuryl alcohol gives a blue color when treated with Dische's reagent which is suitable as a qualitative and semi-quantitative test for furfuryl alcohol. Dische's reagent was prepared according to the procedure given by Sevag, Smolens and Lackman.¹⁸ One microspatula of diphenylamine was placed in a test tube, 3 drops of conc. H₂SO₄ and 6 ml. of glacial acetic acid were added. Three ml. of the aqueous layer was added from the buret and the mixture was heated for 3 minutes in a briskly boiling water bath and then cooled under running water. A pale blue color developed which proved the presence of a little furfuryl alcohol. An equal volume of Dische's reagent was prepared in the same manner and 1 drop of furfuryl alcohol added to it. An intense deep blue color developed.

Next the two layers in the buret were separated by draining off the bottom aqueous layer and the non-aqueous layer was placed in a vacuum desiccator over Anhydrone over night. The next morning the residue was treated with α -naphthylisocyanate according to the procedure given by Shriner and Fuson,¹⁹ but no α -naphthylisocyanate derivatives were recovered.

Next, a series of experiments was made to determine the reversibility of furfuryl alcohol adsorption at various temperatures. The procedure and apparatus used were the same as that already described in the case of furfural except for the inclusion in the system of a sintered glass manostatic valve for maintaining an inert atmosphere, as described by Cavagnol.²⁰ The results are shown in the following table.

| Wt. of catalyst taken | Wt. of furfuryl alcohol taken | Liquid surrounding bulb | Temp. of refluxing liquid | No. of hours of pumping | % furfuryl alcohol removed by pumping |
|-----------------------|-------------------------------|-------------------------|---------------------------|-------------------------|---------------------------------------|
| 2.705 g. | 0.245 g. | air | 28° C. | 66 | 100.0% |
| 2.705 g. | 0.424 g. | acetone | 55° C. | 19 | 100.0% |
| 2.705 g. | 0.360 g. | water | 98° C. | 3 | 87.2% |
| 2.770 g. | 0.427 g. | CCl ₄ | 75° C. | 4 | 79.5% |

¹⁷Deriaz, Stacey, Teece and Wiggins, *J. Chem. Soc.*, 1949, 1222.

¹⁸Sevag, Smolens and Lackman, *J. Biol. Chem.*, 134, 523 (1940).

¹⁹Shriner and Fuson, "Systematic Identification of Organic Compounds," 2nd Edition, John Wiley and Sons, Inc., New York, N.Y., 1940, p. 136.

²⁰Cavagnol, *Anal. Chem.*, 21, 760 (1950).

Since the adsorption of furfuryl alcohol is to some extent irreversible even at a temperature as low as 75°, the adsorptive characteristics of the catalyst toward furfuryl alcohol were not further investigated.

DISCUSSION

In heterogeneous catalysis involving a solid catalyst and liquid or gaseous reactants, some interaction between the catalyst and reactants must obviously occur. Thus a study of the adsorption of the reactants and products of the catalyzed reaction is necessary to elucidate the course of the reaction.

In reviewing the literature, a surprisingly large number of reactions were found in which the activated adsorption of all the reactants did not occur; instead, in many cases, the activated adsorption of only one of the reactants proved sufficient to bring about the catalysis.

During the present investigation, it was found that the catalyst would not adsorb furfural vapor at temperatures below 190°. At this temperature, adsorption did occur, but it was immediately followed by reaction, since no furfural could be recovered from the catalyst. It was shown that the furfural was not converted to either furoin or furil.

In the case of furfuryl alcohol, it was found that irreversible adsorption occurred at temperatures as low as 75°, and that most of the furfuryl alcohol is converted to some material which will not form an α -naphthylurethan derivative, in other words, which does not possess an hydroxyl group.

Thus, it may be concluded that the mechanism of the liquid phase hydrogenation of furfural to furfuryl alcohol in the presence of a cuprous oxide catalyst involves the chemisorption of hydrogen, followed by reaction with molecular, unadsorbed furfural to form unadsorbed furfuryl alcohol. Here again is a case of a catalytic reaction in which some of the adsorption steps are missing.

SUMMARY

1. Cuprous oxide, prepared by the low temperature reduction of a cupric nitrate solution by glucose was found to analyze 2.2% Cu, 64.1% Cu₂O, 26.4% CuO and 7.3% unaccounted for.

2. Vanadium tetroxide, prepared by the low temperature reduction of V₂O₅ by glucose, analyzed 44.1% V₂O₄, 48.2% V₂O₅ and 7.7% unaccounted for.

3. The adsorption of furfural by the catalyst was found not to occur except at high temperatures where the furfural is converted to some other material which is neither furoin nor furil.

4. The adsorption of furfuryl alcohol by the catalyst was found to be irreversible at temperatures as low as 75° and that most of the furfuryl alcohol is converted to some non-hydroxyl-containing material.

DEPARTMENT OF CHEMISTRY
IOWA STATE COLLEGE
AMES, IOWA