

1957

Portland Cement Contents Required to Stabilize Eastern and Western Iowa Loess

R. L. Handy

Iowa Engineering Experiment Station

D. T. Davidson

Iowa Engineering Experiment Station

Copyright ©1957 Iowa Academy of Science, Inc.

Follow this and additional works at: <https://scholarworks.uni.edu/pias>

Recommended Citation

Handy, R. L. and Davidson, D. T. (1957) "Portland Cement Contents Required to Stabilize Eastern and Western Iowa Loess," *Proceedings of the Iowa Academy of Science*, 64(1), 276-313.

Available at: <https://scholarworks.uni.edu/pias/vol64/iss1/35>

This Research is brought to you for free and open access by the Iowa Academy of Science at UNI ScholarWorks. It has been accepted for inclusion in Proceedings of the Iowa Academy of Science by an authorized editor of UNI ScholarWorks. For more information, please contact scholarworks@uni.edu.

Portland Cement Contents Required to Stabilize Eastern and Western Iowa Loess

By R. L. HANDY and D. T. DAVIDSON

INTRODUCTION

Because of existing and predicted future shortages of road-building aggregates, the Iowa State Highway Commission has for several years sponsored research programs to find satisfactory substitutes. A major part of these investigations has been to investigate possible chemical treatments to waterproof and harden natural soils. In locations of most critical aggregate shortages in Iowa, loess, a fine silt soil, is often the major surficial material, and present investigations have been concerned mainly with loess in Iowa. During successive project years different loess soil areas in Iowa have been studied, first to determine petrographic and engineering properties of the soils and second to systematically examine various soil stabilizers with the object of selecting the most promising through laboratory tests. Considering the extremely wide variety of chemicals tried and the various stabilization principles involved, it is significant that one treatment has remained consistently near the head of the list—that of stabilizing soil by adding water and Portland cement. Compacted mixtures of cement and water and soil, termed “soil-cement”, have been used as road base materials since about 1935, and many roads using this material have long and successful service records. The growth in nationwide utilization of soil-cement has been most rapid in recent years, but perhaps as important is the fact that the advent of soil-cement marked the beginning of modern chemical soil stabilization, and field and laboratory procedures adopted for soil-cement have strongly influenced the investigations of other chemicals.

Much of the popularity of soil-cement is related to the development of satisfactory design criteria by the Portland Cement Association, or P.C.A. Early in the history of soil-cement, exhaustive laboratory and field tests were carried out to find correlations necessary to predict field performance. Eventually on the basis of laboratory tests it was possible to estimate the minimum amount of cement required to stabilize a given soil. These laboratory procedures, somewhat modified, are still in use. They define cement requirements mainly on the basis of strength and resistance to artificial weathering (wet-dry and freeze-thaw). For sandy soils, a short cut procedure utilizing particle-size and compressive strength data has been evolved (1). However, for most soils the cement requirements are

still necessarily determined through rather lengthy laboratory tests. Recent efforts by the P.C.A. have been aimed at obtaining satisfactory correlations with other data, and especially with agricultural soil series (2). In connection with this a cooperative program was inaugurated with the Iowa Engineering Experiment Station whereby samples representing Iowa soil series were sent to the P.C.A. for an evaluation of minimum cement requirements. It was believed that with careful field sampling, correlations between cement requirements and other field and laboratory data might be worked out.

OBJECTIVES

Objectives of this program were to find the cement contents required to stabilize various horizons of major upland soil series in typical loess areas in Iowa (Fig. 1).

Preliminary work in the areas in Figure 1 has shown that engineering properties are closely related to clay content (3), and clay content varies systematically over each area (4, 5, 6). Soil classification experts have long recognized this, and each soil series in a loess area must necessarily include a range in soils. It was therefore decided in this investigation to include a minimum of two sample locations for each soil series, and the locations were selected to show variability within a soil series. It was believed that in this way the results would show if the soil series is a reliable criterion for estimat-

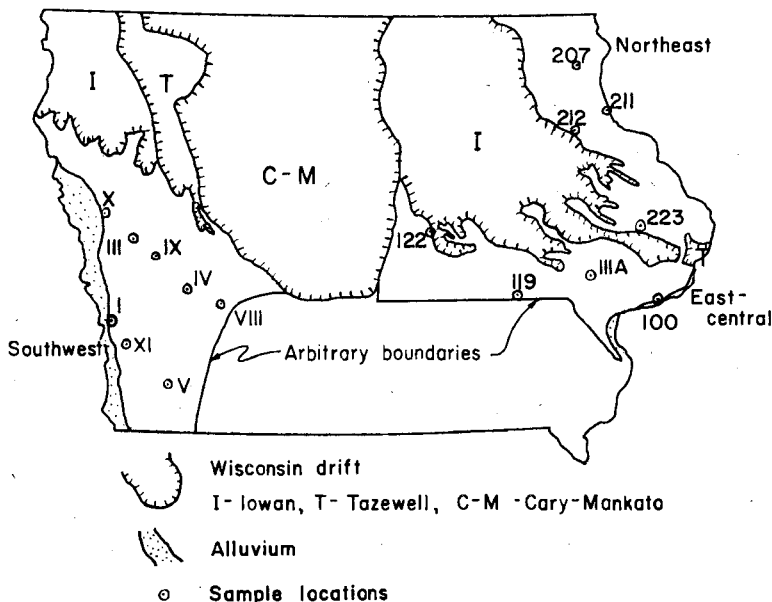

Figure 1. Sample locations in the three loess study areas in Iowa.

ing cement requirement. Should these correlations fail, an alternative was provided; that of possible correlations to basic property data such as mineral composition or grain size.

METHODS AND APPROACH

SAMPLING

Experience in investigating loess sections has shown that soil horizons can be satisfactorily identified in the field on the basis of color, structure, and texture or "feel," and this procedure was followed. Sampling sections were chosen from old sample sites whenever possible so that data already available would show if these sections were representative. The thickness of the loess in some areas, and particularly in western Iowa, put a severe limitation on site selection, since it was desired to sample completely through the sections whenever possible. Therefore, quarry faces and deep roadcuts were utilized.

Figure 2 shows typical sample locations. At each location the samples were made composite with respect to depth; that is, a location might provide a composite A horizon sample, a composite B horizon sample, and so on through to the base of the loess. Since in some soil series certain horizons are missing, the samples were identified by code numbers beginning with the uppermost sample. For example, an A-horizon sample may be numbered 100-1c. The "c" appended to the number indicates a composite sample and automatically instructs the laboratory men to empty the bags and mix the sample. The first number is a location number and for convenience has been coded as follows: 0 to 99 and I to XX, southwest Iowa; 100 to 199, east-central Iowa; 200 to 299, northeast Iowa. Other areas now under investigation are coded in a like manner, but samples from those areas are not included in the present investigation.

Studies of loess profiles have shown the following sequence in weathering: oxidation, leaching of carbonates, and soil profile development (7). Therefore the normal sequence in a loess profile, beginning at the bottom, is (a) unoxidized, calcareous loess, gray in color, usually ending at the water table; (b) oxidized, calcareous loess, tan in color; (c) oxidized, leached loess, in appearance similar to that below, but not reactive to dilute hydrochloric acid; (d) B horizon, higher in clay and often with a blocky structure; (e) A horizon or topsoil, lower in clay than the B horizon and usually darker in color due to the presence of humic organic matter.

Soil Series in Western Iowa

Soil series in western Iowa follow a pattern related to the thickness of the loess. Near the Missouri River where the loess is thickest



Figure 2A. Composite sampling by trenching and augering. Loess, section III, of Ida series.

the rate of erosion has exceeded that of soil profile development, and oxidized, calcareous loess is exposed at the surface of the ground. This is designated in the Hamburg soil series. The Hamburg is transitional to the Ida Series, which is very similar and is represented in the same area. The Ida has a faint, calcareous A horizon, typically about a foot thick and differentiated by its brown color. The Monona soil series is the next transition and represents increased weathering over the Ida; in Monona soils leaching has occurred, and there is the development of a faint B horizon, usually extending to the depth of the leaching. Farther east the leaching and horizon differentiation are more prominent, and the Marshall Series is characteristic of much of southwest Iowa (Fig. 3). A more detailed discussion of series will be found in reference (8).

Because the C horizon is relatively so much more important in soil engineering than in agronomy special attention is warranted. The

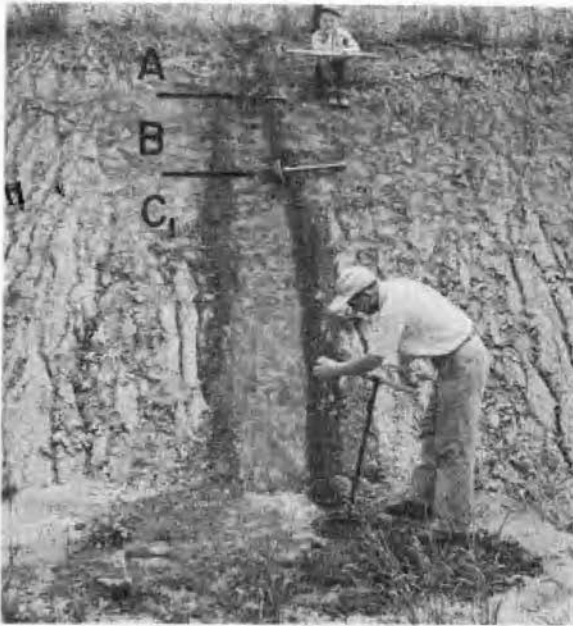

Figure 2B. Loess, section VIII, Marshall series. The soil profile is marked.

C horizon is usually defined as the parent material for the soil profile, and subdivisions of the C based on oxidation or leaching are not of direct concern to the agronomist. Therefore the horizon nomenclature is not well adapted to describing changes in the C. The leached C, transitional to the B, is usually labeled the C_1 horizon. Exact location of the boundary between the B and C horizons is largely a matter of judgment. In this paper the oxidized, calcareous C horizon will be designated simply as the C horizon, and the unoxidized portion will be referred to as the C_G , although objections may be raised because G normally implies deoxidation or gleying. However, a true gley horizon usually carries only the letter G, so there is no direct conflict or overlapping of terms. Concretion zones and iron-enriched zones where present are designated C_{Ca} and C_{Fe} , respectively, as per standard practice. Underlying materials which differ from the soil profile parent material are designated by D. In this case a geologic description has far greater value and is included.

Locations of sample sections are indicated in Figure 1 and are listed in the Appendix in Table 1. Diagrammatic section descriptions of all sections are shown in Figure 4 through 6.

Soil Series in Eastern Iowa

In east-central and northeast Iowa higher annual precipitation has contributed to somewhat greater profile development. Whereas in western Iowa azonal soils such as the Hamburg are fairly common,

in eastern Iowa zonal soils dominate the landscape. The Tama series is the approximate eastern Iowa equivalent of the Marshall, both being prairie soils or brunizems. They are believed to differ primarily in having formed on loess which came from different sources. Less well drained prairie soils in eastern Iowa come under the Muscatine series, and frequently the water table is immediately below the B horizon. The Fayette series is a grey-brown podzolic soil with a profile somewhat similar to that in western Iowa, although coarsest loess is much less extensive (9). Loess with high dolomite content is found locally in Iowa along the Mississippi River, and on the basis of mineral composition correlates more closely with the loess in Illinois than with that in Iowa (5). In recognition of this, a dolomitic loess section (No. 100) is one of those selected in this study. Because of the widespread zonal soil development the characteristics of eastern Iowa soil profiles are not so dependent on parent material as in western Iowa, and series names are used in northeast and east-central Iowa, although mineral analyses in these areas also show distinct differences believed related to sources of the loessal parent material. Reference (9) explains this and is basic to this study.

LABORATORY TESTING PROCEDURE

Testing of soils to determine cement requirements, while a relatively simple procedure, requires extensive laboratory facilities for a large testing program such as this one. Up until now this has proved a main deterrent to large scale testing of Iowa soils to determine cement requirement. It is through the cooperation of the Soil Cement Bureau, Portland Cement Association, that the testing here reported on became possible. In the cooperative study which was initiated largely through the efforts of J. A. Leadabrand and D. T. Davidson, sampling and testing to determine basic soil properties were carried out by the Iowa Engineering Experiment Station in Ames. Samples were then shipped collect to the Portland Cement Association for soil-cement tests in their Skokie, Illinois, laboratory, and finally there was a mutual interchange of data.

Basic Property Tests

Sufficient laboratory tests were run on all samples for classification according to the American Association of State Highway Officials system (A.A.S.H.O.) Designation: M145-49 (10). These tests and methods are as follows:

1. Mechanical analysis. Hydrometer method using an air-jet stirrer and with sodium metaphosphate as the dispersing agent (11).
2. Plasticity index. Method of test according to A.S.T.M. Designation: D427-39 (12).

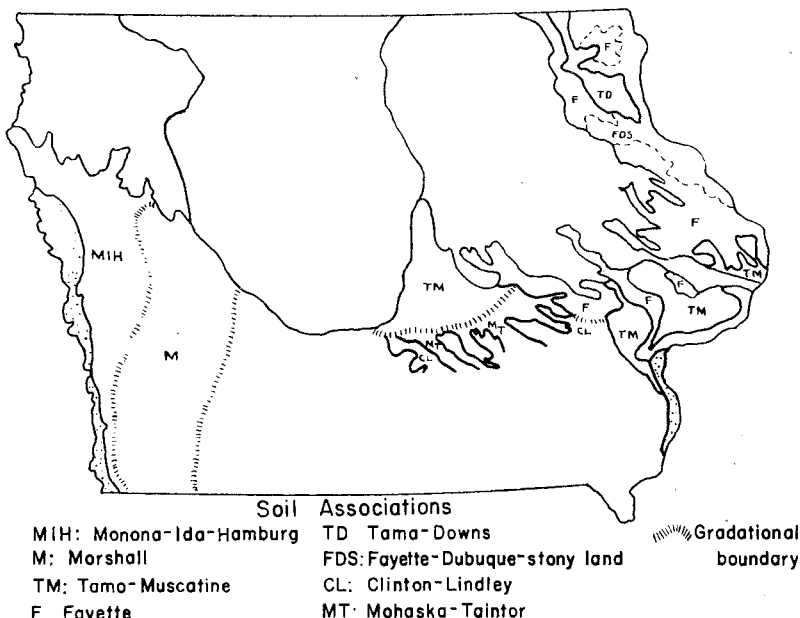

Figure 3. Major upland soil series in the loess areas studied (8).

Other tests were run where special circumstances suggested them. These will be described where introduced.

Soil-Cement Tests

Testing to determine requirements was done as described in "Soil-cement Laboratory Handbook" (13) published in 1956 by the Portland Cement Association. The tests are as follows:

1. Moisture-density test. This is a standardized procedure to determine the optimum water content in a compacted soil or soil-cement mixture. Samples are mixed and molded with varying moisture content but with the same compactive effort. At first water acts as a lubricant and increases the density obtained, but above a certain moisture content so many voids become filled with water that further compaction is impossible. Addition of water above this point gives a decrease in dry density. The water content which gives the highest density is defined as the optimum moisture content and is expressed as a percentage of the oven-dry weight of the soil. This moisture content must be determined for each soil and is used in the soil-cement tests. The test is designed to correlate with field construction practice, and the densities obtained in the laboratory often form a basis for specifications in the field.

2. Wet-dry test. An artificial weathering procedure has been outlined to test the durability of soil-cement mixtures. After 7

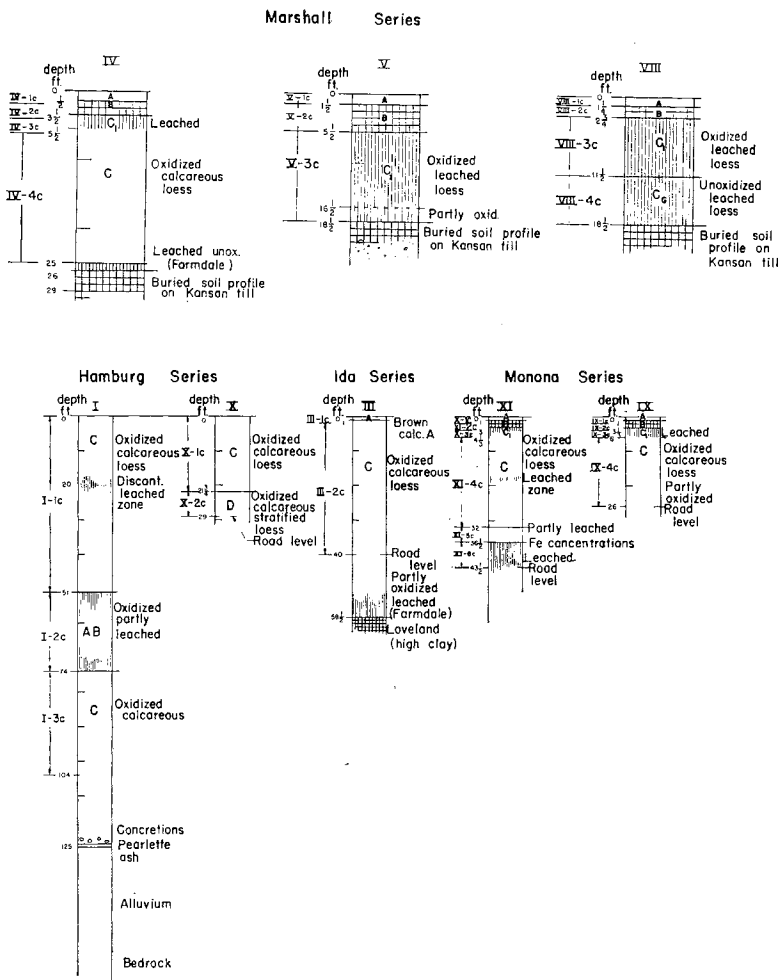

Figure 4. Sample sections in western Iowa.

Fayette Soil Series

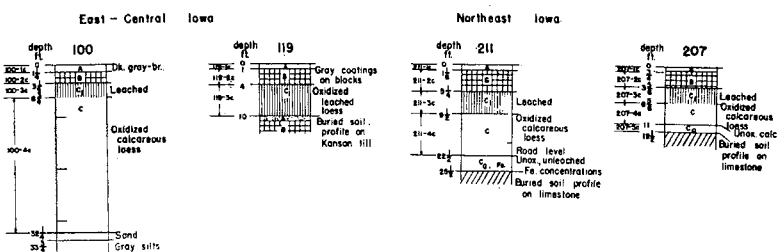

Figure 5. Sample sections in the Fayette series in eastern Iowa.

Tama Series

Muscatine Series

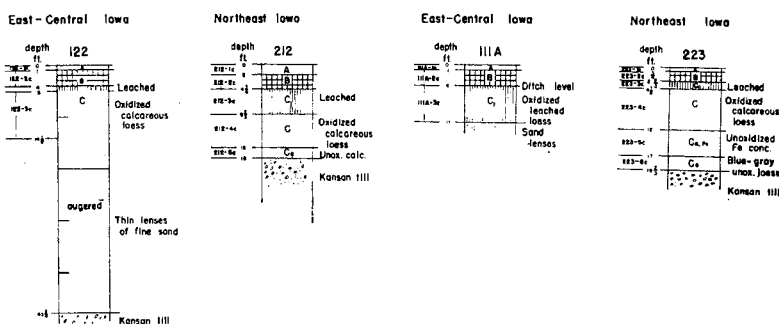

Figure 6. Sample sections in the Tama and Muscatine series in eastern Iowa.

days moist curing, soil-cement specimens are alternately immersed in water, dried, and brushed with a coarse wire brush to remove loose material. After 12 cycles the specimens are weighed to determine soil-cement loss.

3. Freeze-thaw test. A second artificial weathering procedure involves alternate freezing and thawing of 7-day-cured soil-cement specimens. During thawing, specimens are placed on wet felt pads so that they may absorb water. After 12 cycles of freezing, thawing, and brushing, the specimens are weighed to determine soil-cement loss. Standard 4-inch diameter, 4.6-inch high specimens are used in both wet-dry and freeze-thaw tests.

4. Compressive strength test. Compressive strengths of soil-cement specimens are determined after moist curing 2, 7 and 28 days, in order to determine rate of hardening. Usually a soil-cement mixture with a 7-day compressive strength of 300 psi or more will pass the wet-dry and freeze-thaw tests. Compressive strength specimens are soaked in water prior to testing. Specimens 2 inches in diameter and 2 inches high were used for this study.

5. Criteria for soil-cement construction. The above soil-cement tests are run with a number of cement contents for each soil. The minimum cement content for construction must then satisfy wet-dry, freeze-thaw, and compressive strength requirements: During the wet-dry and freeze-thaw tests the soil-cement loss should not exceed 10 per cent for an A-4 soil or 7 per cent for A-6 and A-7 soils. Compressive strengths should increase both with age and with increasing cement contents; if strengths do not increase this indicates a poorly reacting soil and is a danger signal.

RESULTS

PROPERTY TESTS

Results from mechanical analyses are reported in Tables II and III,* and will be discussed in relation to the soil-cement test data. The mechanical analyses confirmed previous field identifications of soil series and profile horizons. The textural classification according to the U. S. Department of Agriculture system of 1951 (14) is also given in the same tables.

Plasticity index results are presented in Tables IV and V,* along with an engineering classification of these soil materials (AASHO Designation: M145-49). Plasticity index, or PI, is related to clay content, as seen in Fig. 7. Plasticity indices for B and C horizon samples show approximately the same relation to clay content, but A horizon samples tend to have a slightly lower PI, probably because of the flocculating influence of humic organic matter. In Fig. 7, for which the equation was obtained from western Iowa C horizon loess samples, four A horizon samples fall above the line and eight come below it. It was necessary to treat the A horizon samples with hydrogen peroxide for removal of organic matter to prevent flocculation during mechanical analysis. It is therefore expected that A horizon samples will tend to compact to lower density and will therefore require more cement.

Part of the scatter in points in Fig 7 is undoubtedly due to the relatively low accuracy of the PI tests. Plasticity indices are ordinarily accurate and reproducible to within 2 or 3 per cent, a large personal factor being involved. Clay contents measured by the hydrometer method are considered accurate to within 1 or 2 per cent.

The basis for the engineering classification of the samples is shown in Fig. 8, which also shows graphically the relatively small but inconsistent variation in plastic limit. Calculation of the standard deviation of the plastic limit from an average value of 22.0 per cent

*These tables will be found in the Appendix.

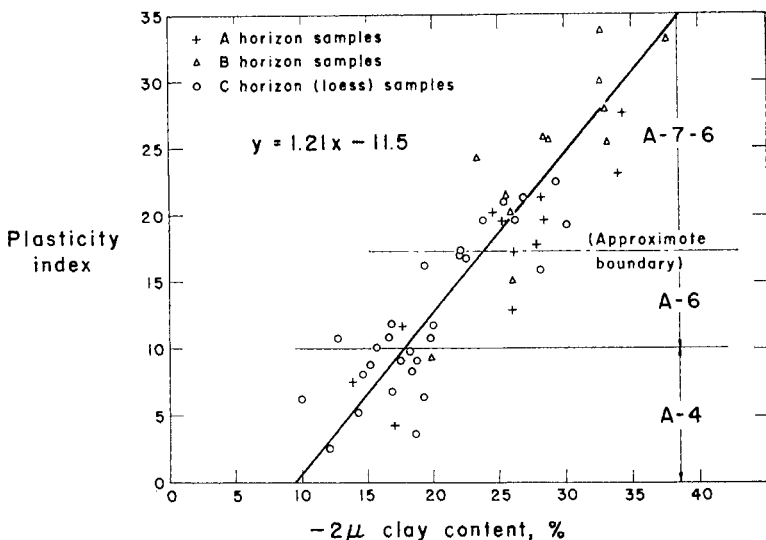

Figure 7. Relation of plasticity index to clay content.

gives a probable error of approximately 1 per cent, indicating that there is a 50 per cent chance that any one plastic limit will fall between 21 and 23 per cent, regardless of liquid limit or clay content.*

SOIL-CEMENT TESTS

The criteria for selecting adequate cement contents to stabilize a soil vary depending on the engineering classification of a soil.

Soil-cement losses during 12 cycles of either the wet-dry test or the freeze-thaw test should not exceed 10 per cent for an A-4 soil or 7 per cent for A-6 and A-7 soils. In addition, compressive strengths should increase both with age and with increasing cement contents. Based on past experience, mixes which meet these specifications will probably be suitable for road base course construction. The sliding scale used to determine the minimum cement content is in recognition of the severe nature of the weathering tests, particularly with regard to sandy or friable silty soils. Brushing to remove loose materials is recognized as a vigorous requirement for these normally poorly cohesive soils. Although the severity of the weathering tests has been criticized, the tests are on the safe side, and there has been a natural reluctance to change them.

Optimum Moisture-Maximum Density

Moisture-density relationships were determined for each sample and the optimum moisture content was evaluated (Fig. 9) and used in subsequent molding of specimens. The addition of Portland cement to a soil usually causes additional flocculation and lowers

*See also (3, p. 203).

the compactibility. Moisture-density tests on raw soil are therefore of less interest than tests on soil-cement mixtures, and tests are therefore run with a cement content which is the estimated cement requirement based on AASHO soil group. At present an A-4 soil is ordinarily tested with 10 per cent cement by weight, an A-6 soil is tested with 12 per cent cement, and an A-7 soil with 13 per cent. Tests must be run quickly, before the cement has a chance to set up. Cement hydration during mixing causes a further decrease in density and increase in optimum moisture.

Data for optimum moisture content and maximum density are presented in Tables X and XI* along with the final results of the soil-cement tests.

Wet-Dry Tests

With only a few exceptions the soil-cement losses during 12 cycles of wetting and drying were exceeded by freeze-thaw losses and therefore were not critical. The losses are listed in Tables VI and VII.* The exceptions are soils for which the freeze-thaw losses are exceptionally low; they are better discussed in that connection.

Compressive Strength

The 2, 7, and 28 day compressive strengths were determined after final evaluation of the required cement content. The data, Tables VIII and IX,* show a sporadic compressive strength gain in a few of the samples. All western Iowa samples show satisfactory strength gains with increasing age. In eastern Iowa, however, many of the A horizon samples show lower strengths at 7 than at 2 days, and most have relatively low strengths after 28 days. Humic materials in Portland cement concrete cause a "flash set" which disturbs the cement structure and causes a considerable loss of mechanical strength. It would appear that the same kind of reaction occurs here. The reaction in concrete is believed to be a flocculation which reduces the availability of gypsum previously added to Portland cement as a retarder. Ordinarily the action of gypsum is to form insoluble calcium aluminate sulfate at the surface of the unhydrated tricalcium aluminate grains, retarding their rate of hydration (15, p. 1239 ff.). The deleterious effect of humus in the A horizons of Fayette, Tama and Muscatine soils might possibly be offset by the use of additional gypsum in the cement, but because of the ease of stripping the relatively thin A horizons, gypsum treatment would be of doubtful utility. For this reason, and because of the higher cement contents indicated by freeze-thaw tests, it is recommended that these A horizons be stripped and not used in soil-cement.

Freeze-Thaw Test

Freeze-thaw loss was the deciding factor for cement content in

*Tables are given in the Appendix.

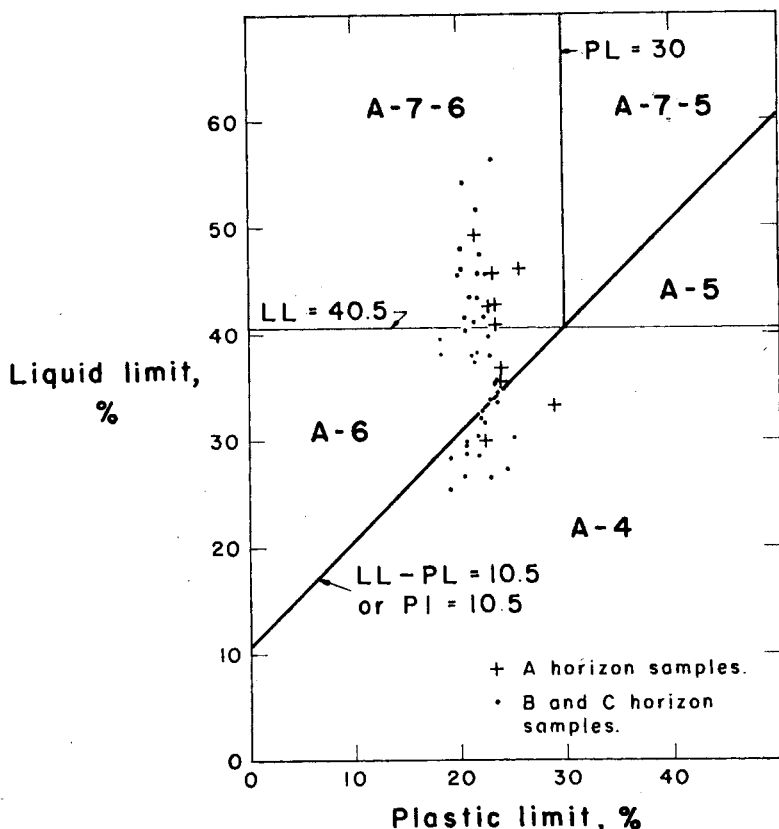

Figure 8. Relation between liquid limit, plastic limit, and A.A.S.H.O. engineering classification of loess soils.

nearly all of the loess soil samples. Data are given in the Appendix, Tables VI and VII. Freeze-thaw losses of some soils were approximately as expected; in other instances they were abnormally high. Cement contents necessary to reduce freeze-thaw losses to within specified limits exceeded 20 per cent for some samples, indicating that Portland cement stabilization would be uneconomical for these soils. Samples which exhibited excessive freeze-thaw losses were from the Ida and Monona series in western Iowa and from the Fayette series in eastern Iowa, but there is a danger in accepting this as a valid correlation. For example the Ida samples give excessive freeze-thaw losses, but the Hamburg samples do not. The Ida series differs from the Hamburg only by development of a faint, unleached A horizon probably because of a slightly lower erosion rate. The series difference is more closely related to topography than to C horizon loess properties, and both series may be found on the same hill. The soil series may not form a reliable criterion in these exceptional cases. In the following pages the correlation with soil series

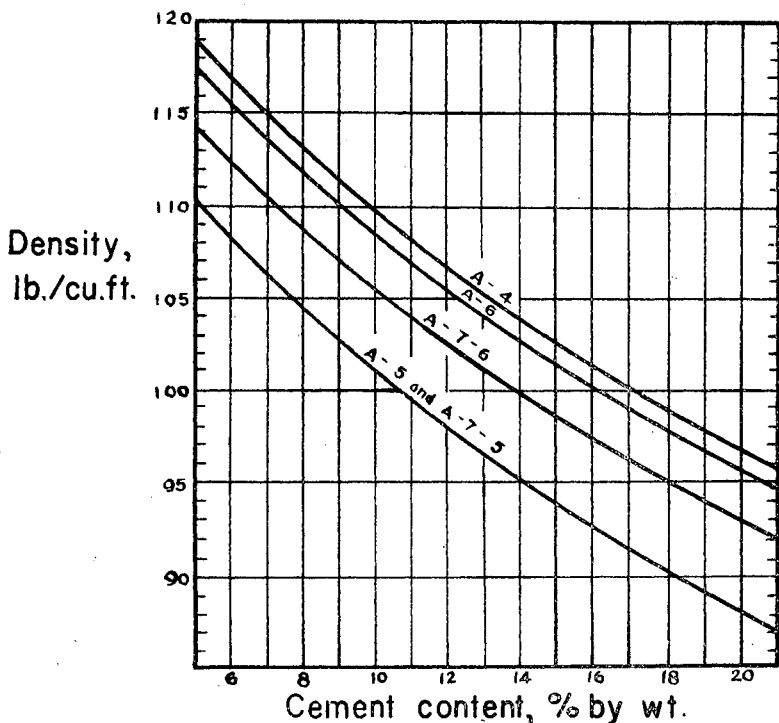

Figure 9. Relation of average cement requirements to compacted density and A.A.S.H.O. soil class. Reproduced from Portland Cement Association, "Soil-Cement Laboratory Handbook" (13).

is presented and discussed, then the results with soil-cement are reviewed and an effort is made to explain them in the light of the basic property data.

For convenience in analysis a freeze-thaw sensitivity factor may be defined. By determining cement requirements for many soils the P.C.A. has been able to draw a graph for estimating probable cement requirements; the graph is reproduced in Fig. 9 and relates cement requirement to compacted density and AASHO soil class. The difference between the values from the graph and the actual cement requirements is taken as an index of freeze-thaw sensitivity, since loess specimens which required additional cement all failed in the freeze-thaw. Use of a freeze-thaw sensitivity serves to minimize the effects of density and soil class variables. The freeze-thaw sensitivity of the samples ranges from minus 2 to over 10 ;the values are shown in Tables IX and X in the Appendix.

DISCUSSION

RELATION TO SOIL SERIES

Western Iowa

The soil-cement test results for western Iowa may be summarized under the following soil series:

Hamburg (5 samples). Compacted density 102 to 108 pcf, optimum moisture 16 to 19 per cent, cement requirement usually 12 per cent.* These results are considered quite favorable, and the samples reacted as expected.

Ida A and C horizons (2 samples). Compacted density around 100 pcf, optimum moisture 18 to 20 per cent, cement requirement 20 per cent. The freeze-thaw sensitivity of these samples is very high, requiring 7 to 9 per cent additional cement over that previously estimated.

Monona C horizon (6 samples). Compacted density 101 to 105 pcf, optimum moisture usually between 18 to 19 per cent. Cement requirements and freeze-thaw sensitivity erratic, the friable (A-4 and A-6) Monona reacting similarly to the Ida, and the more plastic Monona (usually A-7-6) being more like the Marshall. Freeze-thaw sensitivity very high to medium.

Monona and Marshall A horizons (5 samples). Compacted density around 98.5 pcf, optimum moisture 21 to 23 per cent, cement requirement 18 per cent. The high cement requirement is at least partly due to the lower compacted density. Freeze-thaw sensitivity is medium.

Monona and Marshall B horizons (5 samples). Compacted density usually 99 to 103 pcf, optimum moisture 18 to 22 per cent, cement requirement 14 to 16 per cent. Freeze-thaw sensitivity low or medium.

Marshall C horizon (5 samples). Compacted density usually 100 to 104 pcf, optimum moisture about 19 per cent. Cement requirements 16 to 18 per cent. Freeze-thaw sensitivity medium. The cement requirement is 2 per cent lower for material beneath the water table.

Summary: western Iowa. In western Iowa the very coarse loess which is usually in the Hamburg series responds quite favorably to treatment with cement, the required amount being commonly 12 per cent. However, the critical and somewhat unpredictable nature of the freeze-thaw resistance of coarse loess indicates that cement requirements should be checked prior to acceptance of a material for soil-cement construction. Finer loesses and loessal soils are more predictable but are less economical to stabilize. A graphic summary is given in Fig. 10.

Eastern Iowa

Soil-cement test results for eastern Iowa are summarized under the following soil series:

Fayette A horizon (4 samples). Compacted density 96 to 103 pcf, optimum moisture content 17 to 22 per cent. Cement requirement

*Cement requirements are expressed as volume percentages of the finally compacted material.

13.5 per cent and up, depending in part on the density. The density tends to be low due to the influence of organic matter. Some samples show an interrupted compressive strength gain on curing, probably due to deleterious organic matter. Use of Fayette A horizon in soil-cement therefore is not recommended.

Fayette B horizon and leached C horizon (samples). Compacted density 100 to 105 pcf, optimum moisture content 16.5 to 22 per cent. Cement requirement 14.5 per cent in east-central Iowa, much higher in northeast Iowa. The high cement requirements are mainly a result of freeze-thaw sensitivity.

Fayette calcareous C horizon (3 samples). Compacted density, 106 to 109 pcf, optimum moisture content 16.5 to 18 per cent. Cement requirement 9.5 to 14 per cent, averaging 6.3 per cent less than that for the overlying leached C horizon. The average density is about 5 pcf greater, which according to Fig. 9 is about two-thirds sufficient to explain the cement requirement difference. The sand content is not consistently higher in the calcareous than in the leached loess. However, the clay content is consistently lower, undoubtedly due to the transitional nature of the B and C horizons. The calcareous samples contain 8 to 12 per cent less 5 micron clay and would be in the critical frost sensitive range in western Iowa (Fig. 10), yet freeze-thaw loss is not excessive; this will be discussed later. In these samples a lower clay content allows better compaction and a reduction in cement. The single unoxidized sample

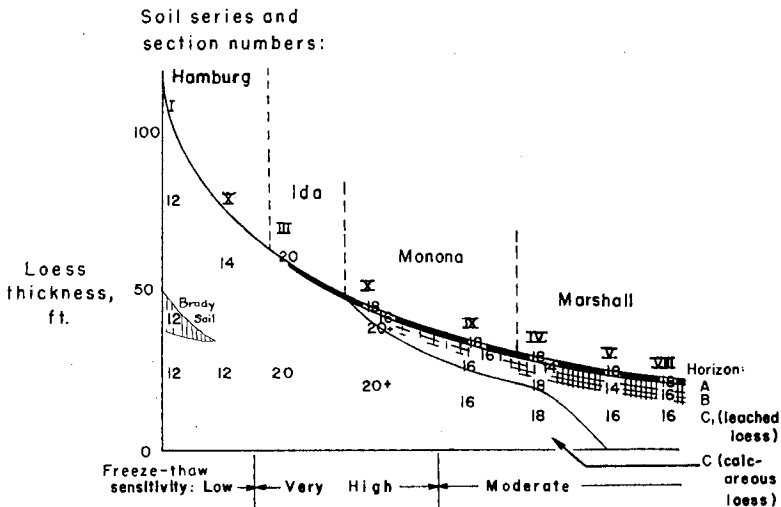

Figure 10. Cement requirements for western Iowa loess and loessal soils. Numbers indicate cement percentages by volume.

reacts much like those which are calcareous and oxidized; it has low clay, high density, and low cement requirement.

Summary: Fayette series. In northeast Iowa Fayette A, B and leached C horizons are highly frost susceptible and unsatisfactory for soil-cement. In east-central Iowa the Fayette A horizon is unsatisfactory, but the B and C horizons can be stabilized with approximately 14 to 15 per cent cement. In both east-central and northeast Iowa the Fayette calcareous C horizon may be stabilized with from 10 to 14 per cent cement; if it were not for the excessive overburden it would be advantageous to use this lower material. The depth of leaching in the loess of eastern Iowa is usually 7 or 8 feet; the thickness of essentially uneroded loess is 10 to 40 feet. Coarse loess requires less cement.

Tama A horizon and Muscatine A horizon (4 samples). Compacted density may be very low, 90 to 103 pcf. Optimum moisture content usually 18 to 20 per cent. Cement requirements erratic and largely influenced by density. Compressive strength shows an interrupted gain. The use of these A horizons ordinarily is not recommended in soil-cement.

Tama B and leached C horizon (3 samples). Compacted density 105 to 107 pcf, optimum moisture content 17 to 18 per cent. Cement requirement 12 to 15 per cent, depending on the texture of the parent material. Coarse-textured loess requires less cement. Freeze-thaw sensitivity moderate.

Tama calcareous C horizon (3 samples). Compacted density 106 to 108 pcf, optimum moisture content 16 to 17 per cent. The cement requirement is 12 to 13 per cent; freeze-thaw sensitivity is moderate.

Muscatine B and leached C horizon (4 samples). Compacted density 100 pcf in the B, 105 to 109 pcf in the C. Optimum moisture content 18 to 20 per cent. Cement requirement 13.5 to 14.5 per cent, freeze-thaw sensitivity moderate.

Muscatine calcareous C horizon (3 samples). Compacted density 107 to 110 pcf, optimum moisture content 15 to 17 per cent. Cement requirement 12 per cent and freeze-thaw sensitivity low except in material enriched in secondary iron. The loess sample with secondary iron has a cement requirement of 13.5 per cent and moderate freeze-thaw sensitivity.

Summary: Tama and Muscatine series. Portland cement stabilization would be most economical with coarse-textured C horizon loess, for which the cement requirement is 12 or 13 per cent. A higher clay content either in the B or C horizons requires additional cement, up to a maximum of about 15 per cent. Iron-oxide enriched

zones may require somewhat more cement than comparable zones without enrichment.

ANALYSIS

After compilation of the results considerable time was spent relating cement requirements to compacted density, per cent air voids, moisture content, clay content, the various plasticity limits, sand content, etc. The only immediate conclusion which could be drawn was that this was a very knotty problem. Cement requirements correlated in a general way with each of these variables, but relating it to any single variable gave a considerable scattering of points. The cement requirement was obviously affected by more than one variable. Such mixing of dependent variables naturally contributes a generous amount of confusion to the analysis, but this is now considered more or less routine in soils investigations and will not be further dwelled upon.

Freeze-Thaw

The critical test for nearly all samples was the freeze-thaw test. First of all weight loss, not strength loss, is the deciding factor for soil-cement. Supplementary observations of severe freeze-thaw failures in samples molded at various densities suggested the mechanism for these failures.

It is widely recognized that water expands on freezing and can exert large pressures—pressures which certainly exceed the relatively low tensile strengths of soil-cement or concrete. Air voids ordinarily present in soil-cement probably provide spaces for ice expansion and act to reduce the pressure (Fig. 11). Pressure in the air voids will more or less follow the familiar relationship $PV = nRT$, whereas pressure in a saturated void will build up much more rapidly with a protracted change in volume. Saturation therefore becomes a critical factor.

In the laboratory testing it was observed that specimens with anomalously high freeze-thaw losses fail by scaling. A surface layer of the specimen forms into loose flakes or scales during freezing, and after subsequent thawing these are brushed off. Additional freeze-thaw cycles then loosen another shell and cause it to be lost. This progressive destruction continues to the end of the test. Some specimens which according to compressive strength should have been stabilized suffered a 100 per cent freeze-thaw loss.

Supplementary investigations using specimens with low cement contents and varying density showed that specimens compacted to high density exhibited tensile cracking and partial loss of strength, as expected from ice crystal expansion. Specimens less well com-

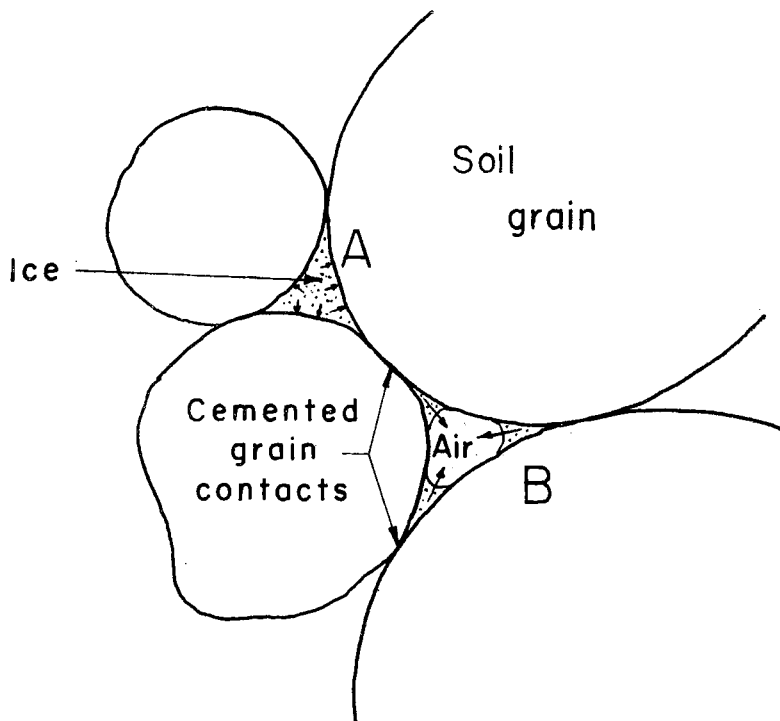

Figure 11. Role of saturation in the disruptive forces exerted by ice. In void A if there is no leakage during freezing, ice pressure will bear directly against soil grains and force them apart. In void B the air is compressible and provides room for ice expansion.

pacted showed excessive scaling and other significant signs of distress, including formation of frost blisters and ice lenses in the outer portions of the specimens. These latter developments suggested very strongly that scaling might be related to water movement and saturation of voids near the outer margins of the specimens during freezing. Moisture measurements made on sections of frozen specimens showed higher moisture contents in the outer shell.

Moisture movement during freezing was suggested some time ago by Taber (16) on the basis of field observations. It is interesting to note that Powers and Helmuth (17) draw on Taber's interpretations to explain ice lense growth in hydrated cement paste. In the case of cement paste, distress is believed due to hydraulic pressure from growing capillary ice forcing water out through the surrounding paste. The low permeability of cement paste aids this buildup of pressure. Contributing to the ice formation is water coming out of individual particles of cement gel. The water thus moves two directions: out of the gel to the capillary voids, for thermodynamic reasons, and out of the filled voids through the paste to unsaturated air voids, for purely physical reasons. Air entrainment in concrete

cuts the pressure buildup by introducing thousands of tiny nuclei for ice formation and pressure relief. The shorter distance through the gel to the air voids reduces the hydraulic pressure.

In soil-cement the cement gel is a much less important constituent than in concrete. Hydraulic pressure in the cement gel may be a factor, but permeability is high in the surrounding soil, and the major mechanism causing freeze-thaw loss appears to be direct ice pressure. The amount of pressure largely depends on the degree of saturation of the air voids, as shown in Fig. 11. This would suggest that voids in the outside of a specimen are saturated due to moisture movement before and during freezing. Thermal osmosis occurs even without freezing (18), but is greatly hastened by the large vapor pressure reduction associated with freezing.

The differential volume change results both in shearing off of the outer shell and in loss of strength within the shell due to failure by tension. Brushing of specimens which fail in this manner may not be so severe as commonly supposed, since the circumferential crack commonly observed in a failure specimen may act as a barrier to capillary movement outward during the next cycle; the moisture buildup and freeze-thaw failure would then be in the next inner shell.

A possible complicating factor in this analysis is the lowering of the freezing point of water due to pressure. However, the minimum temperature at which water can remain liquid is -22° C.,* and this is under a pressure of about 29,200 psi which is far in excess of any containing force that could be developed in soil-cement.

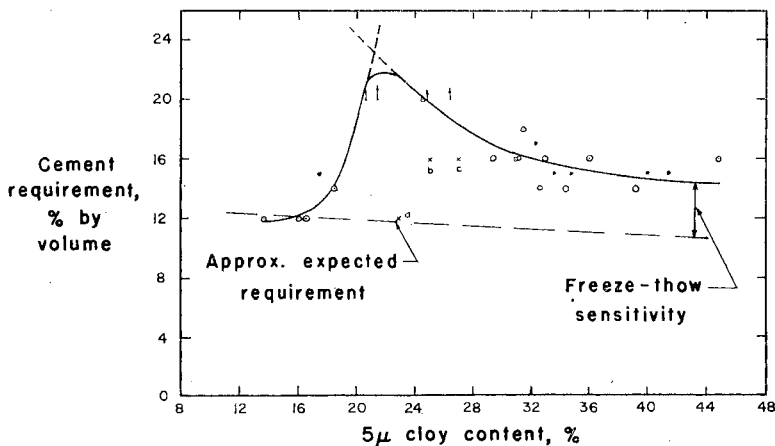

Figure 12. Relation of cement requirement to clay content of western Iowa samples. A horizon requirements, less 3 percent, are shown by dots. Arrows indicate where cement requirements were so high they were not finally determined; these samples showed extreme freeze-thaw sensitivity. Non-correlative samples are Brady soil, a, and basal loess samples b and c.

*This is the critical point between liquid water, ice I, and ice III (19).

Probably more important in lowering the freezing point is the influence of dissolved salts. Salts will tend to be isolated as water freezes out, and concentrated salt solutions may remain in the ice as inclusions. The possible importance of this in curing is discussed elsewhere (23, p. 86).

Progressive freezing undoubtedly occurs, partly as a result of ion concentration but mainly because heat must be conducted away from the freezing solution. As the temperature in a void is lowered, it is questionable where freezing would begin. The crystal structure believed to exist in water absorbed on the basal plane in montmorillonite (20) would probably be a good starting point. The thermal conductivity of minerals is of the order of several times that of water, so cooling would proceed mainly through the mineral grains. It therefore appears that freezing probably extends from the soil grains out into a void.* Thus the first freezing would tend to clog the pores and contain the remaining water so that it will exert pressure during expansion. Otherwise, if the central pore water froze first, the marginal pore water would be free to escape.

Summary for the Mechanism of Freeze-Thaw

The above analysis would suggest that permeability and rate of freezing are two major variables affecting freeze-thaw loss. While a specimen is being frozen a temperature gradient exists which draws capillary water to the outside, saturating the outer pores. In the meantime in these pores freezing has been initiated extending outward from the surface of the clay. If pores are plugged by ice the final water to freeze will be trapped and can exert expansive pressure. If not, the pressure is lost. It therefore appears that two conditions are necessary for high freeze-thaw loss: these are first a high permeability so that sufficient water can move outward to saturate the pores during freezing; increasing the clay content would reduce this permeability and gradually lower the freeze-thaw loss. The second condition is for trapping of the final water; if pores are so large that ice does not quickly clog the pores, pressure will be lost. Water expands only 9 per cent on freezing, so relatively little water movement would be required to relieve the pressure.

Application to Western Iowa Loess

The above discussion can be used to explain Fig. 12. Coarse loess

*The same conclusion can be reached by calculating adsorptive pressures: see Winterkorn (19). That is, under high pressure water freezes even at 40 or 50° C. and so would exist "frozen" on the surface of clay. Decreasing the temperature allows freezing at lower pressures farther out from the clay. An objection to this approach may be that as pressure is further decreased, the freezing point of water continues down until it is below 0° C. Then around a clay particle a zone would exist where water would not freeze so readily. It would freeze closer to the clay and farther from the clay and leave the intermediate zone liquid. This assumption is based on measurements on free water, and it is doubtful if such a condition would exist in the neighborhood of a clay crystal surface.

is not frost susceptible because moisture is not so easily trapped during freezing. With increased clay the moisture can be trapped, and freeze-thaw becomes critical. Further increasing the clay content reduces permeability so that moisture and freeze-thaw loss are progressively less.

Application to Eastern Iowa Loess

The eastern Iowa cement requirement curve (Fig. 13) shows a freeze-thaw sensitivity related to clay content. However, there are some notable differences between this curve and the one for western Iowa samples. All eastern Iowa samples show at least a moderate freeze-thaw sensitivity; their cement requirements are higher than expected. The average difference is about 3 per cent and there is no notable decrease with low per cent clay. Secondly there is a lack of extreme freeze-thaw sensitivity in the neighborhood of 20 to 28 per cent clay which was the sensitive range for loess in western Iowa. A third difference in that high freeze-thaw sensitivity is shown by several samples in the range 30 to 36 per cent clay. It is notable that all four of these samples are from B and leached C horizons of the Fayette series in northeast Iowa.

The freeze-thaw sensitivity of eastern and western Iowa loess does not correlate directly to differences in compacted density. However, on the average the eastern Iowa samples tend to compact to higher density, than those from western Iowa, the average compacted densities for B and C horizon samples being 105 and 102 pcf, respectively. There is little difference in average per cent sand or per cent clay and the ranges covered are about the same. These density data duplicate trends already found for other loess samples from eastern and western Iowa (9). Explanations proposed then were based on microscopic studies which showed a difference in the character of the clay. Variations in grain shape and composition were not believed enough to explain the compactive difference. According to microscopic observations clay occurs more as coatings in loess in eastern Iowa than in western Iowa. Clay could therefore be more effective in compaction by acting as a lubricant between grains. Clay which does not occur as coatings occurs as aggregates, and aggregates are not so readily compacted.

A difference in clay occurrence could help to explain the freeze-thaw data. Clay occurring as coatings becomes concentrated around grain contact areas during mixing, whereas clay as aggregates does not do this so well (21). Clay as coatings may therefore be more effective in lowering the permeability of compacted specimens. In western Iowa about 28 per cent clay was necessary to lower per-

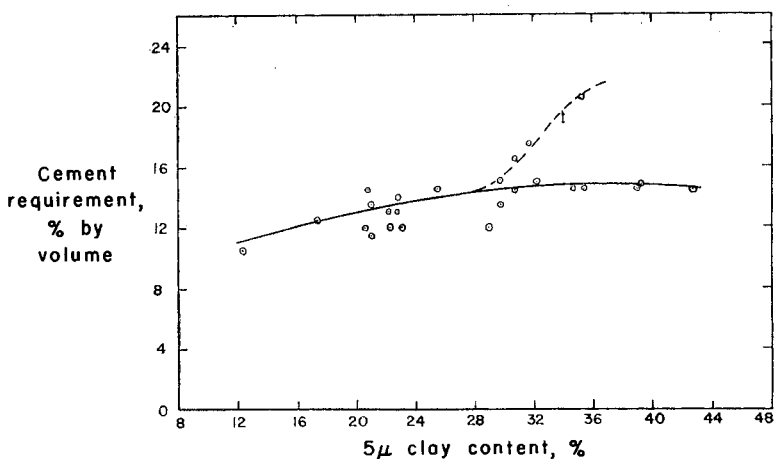

Figure 13. Relation of cement requirement to clay content of eastern Iowa B and C horizon samples. Samples with excessive requirements are from the Fayette series in north-eastern Iowa.

meability and reduce freeze-thaw loss. In eastern Iowa less clay may be necessary; the freeze-thaw loss is thus reduced but not eliminated throughout the clay content range.

The lack of a freeze-thaw sensitive peak in the range 20 to 28 per cent clay may thus be accounted for, but the sensitivity characteristics in the range 30 to 36 per cent clay remain a mystery. As seen in Fig. 13 only certain samples show this high cement requirement; other eastern Iowa samples with practically identical particle size graduations show only moderate susceptibility to freeze-thaw. There is no consistent relation to plasticity, compressive strength, density, or other measured variables. The only constancy is that the four excessively sensitive samples are all from northeast Iowa Fayette B and C horizons. It is possible there is a difference in organic matter or coatings which would explain the high frost susceptibility of these samples, but no data are available to verify this.

CONCLUSIONS

Cement requirements of Iowa loess and loessal soils are imperfectly related to soil series due to erratic susceptibility to freeze-thaw. A theory to explain abnormal freeze-thaw loss is proposed, and freeze-thaw sensitivity is correlated to clay content and clay occurrence as coatings and as aggregates. Excessive freeze-thaw loss appears to be due to scaling caused by void saturation from moisture movement outward in the molded cylinders during freezing. The same process would occur in a road, only moisture movement would be only towards the upper surface. Freeze-thaw loss is prevented

in coarse loess perhaps by inability of ice to quickly plug the pores during freezing. In all areas studied, coarse C horizon loess therefore would be the most economical to stabilize. The cement requirement for this material is usually about 12 per cent. Finer loesses and B horizon materials often have reduced freeze-thaw loss due to low permeability, but the cement requirements are usually 14 to 18 per cent. These requirements are fairly closely related to soil series. Other materials because of high freeze-thaw sensitivity would be completely unsatisfactory for soil-cement, although with some of these materials the cement requirement may be reduced by greater compaction. Another possible solution suggested by the freeze-thaw mechanism is to reduce the freeze-thaw sensitivity by admixing sand. This possibility has not yet been checked. Critical susceptibility to freeze-thaw is evidenced by medium-coarse textured loess in western Iowa and by A and B horizons in the Fayette series in northeastern Iowa. A horizons in eastern Iowa often require excessive cement due to poor compactibility, and some eastern Iowa A horizons react unfavorably with cement. Use of cement with these materials is not recommended.

APPENDIX
 Table 1
 Locations of Sampling Sections

Sample No.	Area*	Location			Remarks	Other Designations
		County	Township	Section		
I	SW	Pottawattamie	T76N, R44W	35, NW Cor.	Active quarry	Crescent City Sec.
X	SW	Monona	T84N, R44W	20, NE Cor.	S roadcut	
III	SW	Monona	T82N, R42W	14, SE $\frac{1}{4}$ SW $\frac{1}{4}$	N roadcut	Soldier Sec.; Loc. 24
XI	SW	Pottawattamie	T74N, R43W	11, NW $\frac{1}{4}$	S roadcut	
IX	SW	Shelby	T81N, R40W	18, NW $\frac{1}{4}$ NW $\frac{1}{4}$	N roadcut	
IV	SW	Shelby	T79N, R38W	16, SE $\frac{1}{4}$ SW $\frac{1}{4}$	N roadcut	Harlan Sec.
V	SW	Montgomery	T71N, R38W	17, SE $\frac{1}{4}$ SW $\frac{1}{4}$	Gravel pit	Red Oak Sec.
VIII	SW	Audubon	T78N, R35W	34, NW $\frac{1}{4}$	E roadcut	
100	E-C	Scott	T77N, R2E	13, N $\frac{1}{2}$ SW $\frac{1}{4}$	Active quarry	Buffalo Sec.
119	E-C	Iowa	T78N, R10W	31, NE $\frac{1}{4}$ NW $\frac{1}{4}$	S roadcut	N. English Sec.
211	NE	Clayton	T92N, R2W	16, SE Cor.	S roadcut	
207	NE	Allamakee	T97N, R5W	23, NE $\frac{1}{4}$ SE $\frac{1}{4}$	N roadcut	
122	E-C	Marshall	T83N, R17W	3, NE $\frac{1}{4}$ SE $\frac{1}{4}$	Abandoned quarry	Quarry Sec.
212	NE	Clayton	T91N, R5W	27, SE $\frac{1}{4}$ SW $\frac{1}{4}$	NE roadcut	
111A	E-C	Muscatine	T78N, R3W	8, SE $\frac{1}{4}$	N roadcut	
223	NE	Clinton	T83N, R1E	26, NE $\frac{1}{4}$ NE $\frac{1}{4}$	SW roadcut	

*SW, southwest Iowa; E-C, east-central Iowa; NE, northeast Iowa.

Table 2
Particle Size Data for Western Iowa Samples

Soil Series	Horizon	Sample No.	% sand	% silt	% clay			U.S.D.A. textural classification
			(2-0.074 mm.)	(0.074-0.005 mm.)	0.005 mm.	0.002 mm.	0.001 mm.	
Hamburg	C	I-1c	3.2	80.3	16.5	14.3	13.3	silt loam
	AB*	-2c	6.2	70.9	22.9	19.9	18.2	silt loam
	C	-3c	8.2	78.2	13.7	12.2	11.4	silt loam
Hamburg	C	X-1c	0.9	80.6	18.5	15.6	14.0	silt loam
	D	-2c	0.7	83.3	16.0	12.8	11.0	silt loam
Ida	A	III-1c†	0.0	67.7	32.3	27.0	24.5	silt loam
	C	-2c	0.5	75.0	24.5	20.0	18.0	silt loam
Monona	A	XI-1c†	0.1	82.5	17.4	25.2	13.7	silt loam
	B	-2c	0.4	68.7	30.9	24.4	21.6	silt loam
	C ₁	-3c	0.4	73.2	26.4	22.0	21.0	silt loam
	C	-4c	0.6	74.8	24.7	18.2	18.0	silt loam
	C _{Fe}	-5c	0.3	78.3	21.4	16.8	15.9	silt loam
Monona	C ₁	-6c	0.2	79.2	20.6	16.6	15.6	silt loam
	A	IX-1c†	0.7	65.7	33.6	28.3	26.2	si. cl. lo.
	B	-2c†	0.5	68.3	31.2	25.9	22.6	silt loam
	C ₁	-3c	0.5	70.1	29.4	23.8	20.9	silt loam
	C	-4c	0.7	74.3	25.0	19.4	17.5	silt loam
Marshall	A ₃	IV-1c†	0.8	59.3	39.9	34.0	30.0	si. cl. lo.
	B	-2c†	0.4	65.2	34.4	28.4	25.5	si. cl. lo.
	C ₁	-3c	0.3	68.2	31.5	25.4	22.0	silt loam
	C	-4c	0.4	72.6	27.0	22.5	19.8	silt loam
Marshall	A	V-1c†	0.5	64.7	34.8	28.4	24.9	silt loam
	B	-2c†	0.3	60.4	39.3	33.0	30.4	si. cl. lo.
	C ₁	-3c	0.4	66.6	33.0	26.9	23.9	silt loam
Marshall	A	VIII-1c†	0.4	58.3	41.3	34.3	29.9	si. cl. lo.
	B	-2c†	0.4	54.8	44.8	37.6	33.2	si. cl. lo.
	C ₁	-3c	0.4	63.6	36.0	29.3	26.0	silt loam
	C _G	-4c	0.8	66.6	32.6	26.2	23.0	silt loam

*Buried (fossil) profile.

†Treated with 30 percent H₂O₂ to prevent flocculation during grain size analysis.

Table 3
Particle Size Data for Eastern Iowa Samples

Area and Soil Series	Horizon	Sample No.	% sand (2-0.074 mm.)	% silt (0.074-0.005 mm.)	% clay			U.S.D.A. textural classification
					0.005 mm.	0.002 mm.	0.001 mm.	
E-C Iowa Fayette	A	100-1c†	2.1	62.6	35.4	27.8	23.0	si. cl. lo.
	B	-2c	0.1	60.9	39.0	32.7	29.0	si. cl. lo.
	C ₁	-3c	1.0	78.2	20.8	17.5	15.1	silt loam
	C	-4c	8.3	79.4	12.3	10.0	8.3	silt
E-C Iowa Fayette	A	119-1c†	1.2	64.8	34.0	26.0	21.0	silt loam
	B	-2c	0.7	56.6	42.7	32.6	25.6	si. cl. lo.
	C ₁	-3c	3.4	62.9	34.7	31.1	30.6	si. cl. lo.
NE Iowa Fayette	A	211-1c†	2.0	77.8	20.1	13.8	10.3	silt loam
	B	-2c	0.8	65.2	34.0	25.5	19.8	silt loam
	C ₁	-3c	0.5	67.8	31.7	23.4	17.8	silt loam
	C	-4c	0.7	78.2	21.1	14.6	10.4	silt loam
NE Iowa Fayette	A	207-1c	1.7	75.1	23.1	17.0	14.1	silt loam
	B	-2c	0.4	68.9	30.7	26.0	24.5	silt loam
	C ₁	-3c	0.5	64.3	35.2	30.1	28.3	si. cl. lo.
	C	-4c	0.4	76.7	22.9	18.3	17.2	silt loam
	C _G	-5c	0.3	77.5	22.2	16.9	16.8	silt loam
E-C Iowa Tama	A	122-1c	2.3	71.5	26.2	21.8	20.0	silt loam
	B	-2c	2.4	68.6	29.0	25.5	24.5	silt loam
	C	-3c	5.0	77.6	17.4	15.8	15.4	silt loam
NE Iowa Tama	A	212-1c	3.4	71.6	25.0	17.7	12.9	silt loam
	B	-2c	2.3	74.9	32.2	28.8	28.3	si. cl. lo.
	C ₁	-3c	3.1	71.4	25.5	22.1	21.3	silt loam
	C	-4c	1.2	66.6	22.8	19.8	19.4	silt loam
	C _G	-5c	2.4	74.5	23.1	15.2	9.3	silt loam
E-C Iowa Muscatine	A	111A-1c	3.3	64.7	32.0	26.0	24.4	silt loam
	B	-2c	2.1	57.6	39.3	32.8	30.0	si. cl. lo.
	C ₁	-3c	0.8	69.4	29.8	24.4	23.8	silt loam
NE Iowa Muscatine	A	223-1c	0.8	67.6	31.6	26.2	23.2	silt loam
	B	-2c	0.7	63.9	35.4	33.2	32.6	si. cl. lo.
	C ₁	-3c	0.3	69.0	30.7	28.1	27.3	si. cl. lo.
	C	-4c	0.8	78.6	20.6	18.7	18.2	silt loam
	C _{G, Fe}	-5c	0.9	78.1	21.0	19.3	19.0	silt loam
	C _G	-6c	1.4	76.3	22.3	18.8	18.3	silt loam

†Treated with 30 percent H₂O₂ to prevent flocculation during grain size analysis.

Table 4
Engineering Classification of Western Iowa Samples

Soil Series	Horizon	Sample No.	Plasticity			AASHTO Soil Class
			Liquid Limit, %	Plastic Limit, %	Plasticity Index	
Hamburg	C	I-1c	30.3	25.1	5.2	A-4(8)
	AB	-2c	31.8	22.4	9.4	A-4(8)
	C	-3c	27.3	24.7	2.6	A-4(8)
Hamburg	C	X-1c	32.1	22.0	10.1	A-4(8)
	D	-2c	33.9	23.0	10.9	A-6(8)
Ida	A	III-1c	46.1	25.9	20.2	A-7-6(13)
	C	-2c	35.2	23.4	11.8	A-6(8)
Monona	A	XI-1c	42.9	23.4	19.5	A-7-6(13)
	B	-2c	45.8	22.3	23.5	A-7-6(15)
	C ₁	-3c	39.9	22.9	17.0	A-6(11)
	C	-4c	33.5	23.7	9.8	A-4(8)
	C _{Fe}	-5c	35.7	23.8	11.9	A-6(8)
Monona	C ₁	-6c	34.6	23.8	10.8	A-6(8)
	A	IX-1c	44.7	23.3	21.4	A-7-6(14)
	B	-2c	41.8	21.5	20.3	A-7-6(13)
	C ₁	-3c	41.2	21.5	19.7	A-7-6(12)
Marshall	C	-4c	37.9	21.7	16.2	A-6(11)
	A ₃	IV-1c	45.8	22.7	23.1	A-7-6(14)
	B	-2c	46.0	20.1	25.9	A-7-6(16)
	C ₁	-3c	41.7	20.7	21.0	A-7-6(13)
Marshall	C	-4c	38.0	21.2	26.8	A-6(11)
	A	V-1c	42.6	22.9	19.7	A-7-6(12)
	B	-2c	48.0	20.1	27.9	A-7-6(17)
Marshall	C ₁	-3c	39.6	18.3	21.3	A-6(13)
	A	VIII-1c	49.2	21.6	27.6	A-7-6(17)
	B	-2c	56.3	23.1	33.2	A-7-6(19)
	C ₁	-3c	43.6	21.1	22.5	A-7-6(14)
	C _G	-4c	40.4	20.7	19.7	A-6(12)

Table 5
Engineering Classification of Eastern Iowa Samples

Area and Soil Series	Horizon	Sample No.	Plasticity			AASHO Soil Class
			Liquid Limit, %	Plastic Limit, %	Plasticity Index	
E-C Iowa Fayette	A	100-1c	41.0	23.3	17.7	A-7-6(9)
	B	-2c	54.1	20.3	33.8	A-7-6(14)
	C ₁	-3c	30.0	20.9	9.1	A-4(8)
	C	-4c	25.5	19.2	6.3	A-4(8)
E-C Iowa Fayette	A	119-1c	36.9	24.0	12.9	A-6(7)
	B	-2c	51.8	21.8	30.0	A-7-6(14)
	C ₁	-3c	38.1	18.2	19.9	A-6(10)
NE Iowa Fayette	A	211-1c	30.0	22.5	7.5	A-4(8)
	B	-2c	43.4	21.9	21.5	A-7-6(11)
	C ₁	-3c	45.8	21.9	23.9	A-7-6(13)
	C	-4c	28.9	20.7	8.2	A-4(8)
NE Iowa Fayette	A	207-1c	33.3	29.0	4.3	A-4(8)
	B	-2c	38.0	23.0	15.0	A-6(9)
	C ₁	-3c	41.7	22.4	19.3	A-7-6(10)
	C	-4c	30.2	21.8	8.4	A-4(8)
	C _G	-5c	28.6	21.9	6.7	A-4(8)
E-C Iowa Tama	A	122-1c	32.9	24.0	8.9	A-4(8)
	B	-2c	33.9	21.2	12.7	A-6(9)
	C	-3c	25.4	23.6	1.8	A-4(8)
NE Iowa Tama	A	212-1c	35.7	24.0	11.7	A-6(8)
	B	-2c	47.7	22.0	25.7	A-7-6(16)
	C ₁	-3c	39.1	21.8	17.3	A-6(10)
	C	-4c	32.8	22.1	10.7	A-6(7)
	C _G	-5c	29.6	20.8	8.8	A-4(8)
E-C Iowa Muscatine	A	111A-1c	39.2	26.2	13.0	A-6(9)
	B	-2c	39.1	24.0	15.1	A-6(10)
	C ₁	-3c	30.8	21.8	9.0	A-4(8)
NE Iowa Muscatine	A	223-1c	40.7	23.5	17.2	A-7-6(10)
	B	-2c	45.5	20.0	25.5	A-7-6(13)
	C ₁	-3c	37.4	21.5	15.9	A-6(9)
	C	-4c	26.6	23.0	3.6	A-4(8)
	C _{G, Fe}	-5c	26.8	20.4	6.4	A-4(8)
	C _G	-6c	28.2	19.1	9.1	A-4(8)

Table 6
Freeze-Thaw and Wet-Dry Losses for Western Iowa Soil-Cement*

Soil series	Horizon	Sample No.	Cement content, per cent by volume					Allowable loss, %	Cement req., vol. %	
			10	12	14	16	18			20
Hamburg	C	I-1c	18	4(3)	3				10	12
	AB	-2c	32	6(3)	5				10	12
	C	-3c	8	8(3)	4				10	12
Hamburg	C	X-1e	17	14(10)	5				10	14
	D	-2e	9	6(7)	5				7	12
Ida	A	III-1c			40	15(3)	14	5	7	20
	C	-2c	52	40(60)	22	18	17		7	20
Monona	A	XI-1c			22	7(3)	7		7	18
	B	-2c		12	6(14)	3			7	16
	C ₁	-3c	55	45(5)	23	18	18		7	20+
	C	-4c	48	37(3)	17	19	14		10	20+
	C _{Fe}	-5c	82	64	37	27	23		7	20+
Monona	C ₁	-6c	100	36(3)	19	19	13		7	20+
	A	IX-1c			34	26(4)	4		7	18
	B	-2c	46	36(6)	26	6			7	16
	C ₁	-3c	45	25(1)	24	6			7	16
	C	-4c		50(9)	18	2			7	16
Marshall	A _s	IV-1c			29	23(7)	3	2	7	18
	B	-2c	76	33(4)	4	3			7	14
	C ₁	-3c		70(6)	36	16	7		7	18
	C	-4c	40	24(7)	12				7	16
Marshall	A	V-1c			59	37(3)	6		7	18
	B	-2c	33	12(8)	3	3			7	14
	C ₁	-3c	60	45(6)	14	6			7	16
Marshall	A	VIII-1c			23	19(12)	4		7	18
	B	-2c	40	33(7)	13				7	16
	C ₁	-3c	62	56(5)	34	7			7	16
	C _G	-4c	12	5(4)	5				7	14

*Wet-dry soil-cement losses are shown in parentheses.

Handy and Davidson: Portland Cement Contents Required to Stabilize Eastern and Weste

Table 7
Freeze-Thaw and Wet-Dry Losses for Eastern Iowa Soil-Cement, Percent*

Area and soil series	Horizon	Sample no.	Cement content, per cent by weight																	Allowable loss, %	Cement requirement, %	
			9	10	11	12	13	14	15	16	17	18	19	20	21x	22	23	24	25		by wt.	by vol.
E-C Iowa Fayette	A	100-1c				10			5(5)											7	14.0	13.5
	B	-2c			34			28(15)	8											7	15.5	14.5
	C ₁	-3c	8	25		19(4)				5	4									10	15.0	14.5
	C	-4c			3(5)		3													10	9.0	9.5
E-C Iowa Fayette	A	119-1c							51											7	20.0	17.0
	B	-2c						6												7	16.0	14.5
	C ₁	-3c			38		12(6)		6	6(4)										7	15.0	14.5
NE Iowa Fayette	A	211-1c			44															10	23+	
	B	-2c																		7	21+	
	C ₁	-3c				(9)														7	21+	
	C	-4c				(7)														7	18.5	17.5
NE Iowa Fayette	A	207-1c																		10	11.0	11.5
	B	-2c				65														10	23.0	19.5
	C ₁	-3c				46														7	17.5	16.5
	C	-4c						(6)												7	23.5	20.5
	C _G	-5c	22		59		12(8)		7											10	14.0	14.0
E-C Iowa Tama	A	122-1c																		10	12.5	13.0
	B	-2c				6				13										10	17.0	17.0
	C	-3c				3				4										7	12.0	12.5
NE Iowa Tama	A	212-1c																		10	12.0	12.5
	B	-2c		83		26(4)														7	19.0	17.0
	C ₁	-3c	63		31(5)															7	15.0	15.0
	C	-4c	27		22(5)															7	15.0	14.5
	C _G	-5c	23		14(8)															7	13.0	13.0
E-C Iowa Muscatine	A	111A-1c				100														10	12.0	12.0
	B	-2c								100(5)										7	21+	
	C ₁	-3c			32															7	15.5	14.5
NE Iowa Muscatine	A	223-1c																		10	13.0	13.5
	B	-2c				12														7	13.0	14.0
	C ₁	-3c				17														7	16.0	14.5
	C	-4c				17(4)				16(5)										7	15.0	14.5
	C _{G, Fe}	-5c				15				16										10	12.0	12.0
	C _G	-6c	40		25(4)		18			3										10	13.0	13.5
					15(8)		3												10	12.0	12.0	

*Wet-dry soil-cement losses are shown in parentheses.

NINETY-SIX—Academy of Science—1746

Table 8
Compressive Strengths of Eastern Iowa Soil-Cement

Area and Soil Series	Horizon	Sample No.	Cem. Cont., % by wt.	Compressive strength, psi		
				2	7	28 day
E-C Iowa Fayette	A	100-1c	14.0	287	239	503
	B	-2c	15.5	334	420	436
	C ₁	-3c	15.0	290	318	474
	C	-4c	9.0	201	287	363
E-C Iowa Fayette	A	119-1c	20.0	169	229	261
	B	-2c	16.0	160	204	375
	C ₁	-3c	15.0	275	299	408
NE Iowa Fayette	A	211-1c	—	—	—	—
	B	-2c	—	—	—	—
	C ₁	-3c	18.5	318	382	487
	C	-4c	11.0	236	344	452
NE Iowa Fayette	A	207-1c	23.0	239	165	360
	B	-2c	17.5	242	318	494
	C ₁	-3c	23.5	303	357	600
	C	-4c	14.0	337	541	840
	C _G	-5c	12.5	424	478	815
E-C Iowa Tama	A	122-1c	17.0	245	300	
	B	-2c	12.0	185	300	
	C	-3c	12.0	290	446	
NE Iowa Tama	A	212-1c	19.0	204	143	280
	B	-2c	15.0	194	264	366
	C ₁	-3c	15.0	245	306	572
	C	-4c	13.0	404	420	655
	C _G	-5c	12.0	401	541	713
E-C Iowa	A	111A-1c	—	—	—	—
	B	-2c	15.5	160	280	
	C ₁	-3c	13.0	222	382	
NE Iowa Muscatine	A	223-1c	13.0	268	251	299
	B	-2c	16.0	280	337	401
	C ₁	-3c	15.0	286	271	608
	C	-4c	12.0	356	455	446
	C _{G, Fe}	-5c	13.0	343	445	748
	C _G	-6c	12.0	337	325	502

Table 9
Compressive Strengths for Western Iowa Soil-Cement

Soil Series	Horizon	Sample No.	Cem. Cont., % by vol.	Compressive strength, psi		
				2	7	28 day
Hamburg	C	I-1c	12	286	420	560
	AB	-2c	12	347	528	542
	C	-3c	12	344	388	636
Hamburg	C	X-1c	14	242	484	725
	D	-2c	12	236	248	489
Ida	A	III-1c	20	414	458	554
	C	-2c	18*	341	535	572
Monona	A	XI-1c	18	286	363	363
	B	-2c	16	280	420	432
	C ₁	-3c	16**	306	471	667
	C	-4c	16**	280	509	719
	C _{Fe}	-5c	16**	382	395	566
	C ₁	-6c	16**	274	446	630
Monona	A	IX-1c	18	286	388	407
	B	-2c	16	318	388	489
	C ₁	-3c	16	382	503	521
	C	-4c	16	414	477	620
Marshall	A ₃	IV-1c	18	239	318	318
	B	-2c	14	286	337	623
	C ₁	-3c	18	363	471	471
	C	-4c	16	337	509	879
Marshall	A	V-1c	18	286	325	375
	B	-2c	14	267	318	343
	C ₁	-3c	16	—	—	—
Marshall	A	VIII-1c	18	331	388	388
	B	-2c	16	255	331	716
	C ₁	-3c	16	267	420	420
	C _G	-4c	14	223	356	534

*Freeze-thaw cement requirement 20%.

**Freeze-thaw cement requirement over 20%.

Table 10
Soil-Cement Results and Freeze-Thaw Sensitivity of Western Iowa Samples

Soil Series	Horizon	Sample No.	Opt. M.C., %	Est. Dens., pcf	Est. Cem. Req., wt. %	Recommended Cem. Cont., %		Freeze-thaw sensitivity
						by wt.	by vol.	
Hamburg	C	I-1c	17.9	102.9	14.8	12.2	12	-2.6
	AB	-2c	16.5	107.8	11.2	11.7	12	0.5
	C	-3c	15.8	107.7	11.3	11.7	12	0.4
Hamburg	C	X-1c	18.5	103.0	14.8	14.0	14	-0.8
	D	-2c	19.0	102.3	14.3	12.4	12	-1.9
Ida	A	III-1c	19.5	99.4	14.4	23.3	20	8.9
	C	-2c	18.5	100.0	16.0	23.2	20	7.2
Monona	A	XI-1c	22.5	98.5	15.0	20.8	18	5.8
	B	-2c	22.0	98.7	15.1	18.0	16	2.9
	C ₁	-3c	18.0	105.0	12.3	21.8	20	9.5
	C	-4c	18.6	102.0	15.4	22.6	20	7.2
	C _{Fe}	-5c	19.3	101.3	15.0	21.3	20	6.3
Monona	C ₁	-6c	18.3	102.0	14.6	22.6	20	8.0
	A	IX-1c	21.0	98.6	15.0	20.7	18	5.7
	B	-2c	18.3	103.2	11.5	17.0	16	5.5
	C ₁	-3c	19.0	103.3	11.5	17.0	16	5.5
Marshall	C	-4c	18.7	103.8	13.1	16.9	16	3.8
	A ₃	IV-1c	23.3	94.5	18.3	21.8	18	3.5
	B	-2c	18.8	102.3	12.3	14.8	14	2.5
	C ₁	-3c	18.8	103.0	11.8	19.6	18	7.8
Marshall	C	-4c	19.5	99.6	16.3	17.7	16	1.4
	A	V-1c	21.5	98.3	15.2	20.8	18	5.6
	B	-2c	21.5	99.0	14.3	15.3	14	1.0
	C ₁	-3c	18.7	104.2	12.6	16.8	16	4.2
Marshall	A	VIII-1c	21.3	98.4	15.0	20.8	18	5.8
	B	-2c	22.0	98.8	14.6	17.9	16	3.3
	C ₁	-3c	18.7	103.3	11.5	17.0	16	5.5
	C _G	-4c	21.3	98.4	17.5	15.4	14	2.1

Table 11
Soil-Cement Results and Frost Sensitivity of Eastern Iowa Samples

Area and Soil Series	Horizon	Sample No.	Opt. M.C., %	Est. Dens., pcf	Est. Cem. Req., wt. %	Recommended Cem. Cont., %		Frost sensitivity
						by wt.	by vol.	
E-C Iowa	A	100-1c	19.3	102.7	12.0	14.0	13.5	2.0
	B	-2c	18.7	101.5	12.6	15.5	14.5	2.9
	C ₁	-3c	17.0	105.4	12.9	15.0	14.5	2.1
	C	-4c	15.3	109.2	10.0	9.0	9.5	1.0
E-C Iowa	A	119-1c	22.1	96.1	19.7	20.0	17.0	0.3
	B	-2c	21.7	100.1	14.0	16.0	14.5	2.0
	C ₁	-3c	19.8	103.5	13.5	15.0	14.5	1.5
NE Iowa Fayette	A	211-1c	17.3	102.0	15.5	23	20	7.5
	B	-2c	16.5	104.0	11.0	21	19	10
	C ₁	-3c	17.8	104.3	10.8	18.5	17.5	8.3
	C	-4c	16.2	106.6	12.1	11.0	11.5	-0.9
NE Iowa Fayette	A	207-1c	18.9	100.0	17.0	23.0	19.5	6.0
	B	-2c	19.2	102.7	14.0	17.5	16.5	3.5
	C ₁	-3c	18.1	101.3	12.7	23.5	20.5	10.8
	C	-4c	16.6	108.1	11.0	14.0	14.0	3.0
	C _G	-5c	15.8	109.6	10.0	12.5	13.0	2.5
E-C Iowa Tama	A	122-1c	18.4	102.8	14.9	17.0	17.0	2.1
	B	-2c	17.5	105.2	12.0	12.0	12.0	0
	C	-3c	16.0	107.8	8.9	12.0	12.0	3.1
NE Iowa	A	212-1c	19.2	99.8	16.2	19.0	17.0	2.8
	B	-2c	18.0	104.8	10.5	15.0	15.0	4.5
	C ₁	-3c	17.5	106.7	11.2	15.0	14.5	3.8
	C	-4c	17.3	106.0	11.5	13.0	13.0	1.5
	C _G	-5c	15.7	107.9	11.2	12.0	12.0	0.8
E-C Iowa	A	111A-1c	24.3	91.3	21	21	21	—
	B	-2c	20.2	99.8	14.0	15.5	14.5	1.5
	C ₁	-3c	16.7	108.9	10.5	13.0	13.5	2.5
NE Iowa Muscatine	A	223-1c	19.7	99.6	14.2	13.0	14.0	-1.2
	B	-2c	18.5	100.1	13.8	16.0	14.5	2.2
	C ₁	-3c	18.0	105.1	12.0	15.0	14.5	3.0
	C	-4c	16.5	106.8	12.0	12.0	12.0	0
	C _{G, Fe}	-5c	15.2	110.4	9.5	13.0	13.5	3.5
	C _G	-6c	17.3	107.6	11.3	12.0	12.0	0.7

Table 12
Corresponding Iowa and P.C.A. Sample Numbers

Western Iowa		Eastern Iowa	
I.E.E.S.*	P.C.A.	I.E.E.S.*	P.C.A.
I-1c	515	100-1c	548
-2c	516	-2c	549
-3c	517	-3c	550
X-1c	520	-4c	551
-2c	521	119-1c	552
III-1c	518	-2c	553
-2c	519	-3c	554
XI-1c	522	211-1c	537
-2c	523	-2c	538
-3c	524	-3c	539
-4c	525	-4c	540
-5c	526	207-1c	528
-6c	527	-2c	529
IX-1c	511	-3c	530
-2c	512	-4c	531
-3c	513	-5c	532
-4c	514	122-1c	
IV-1c	500	-2c	
-2c	501	-3c	
-3c	502	212-1c	533
-4c	503	-2c	534
V-1c	504	-3c	535
-2c	505	-4c	536
-3c	506	-5c	541
VIII-1c	507	111A-1c	
-2c	508	-2c	
-3c	509	-3c	
-4c	510	223-1c	542
		-2c	543
		-3c	544
		-4c	545
		-5c	546
		-6c	547

*Iowa Engineering Experiment Station.

ACKNOWLEDGEMENTS

The material for this paper was obtained as part of the research being done under Project 283-S of the Iowa Engineering Experiment Station, Iowa State College. This project, entitled "The Loess and Glacial Till Materials of Iowa An Investigation of Their Physical and Chemical Properties and Techniques for Processing Them to Increase Their All-Weather Stability for Road Construction," is being carried on under contract with the Iowa State Highway Commission and under sponsorship of the Iowa Highway Research Board. It is supported by funds supplied by the Commission and the U. S. Bureau of Public Roads.

To Dr. C. J. Roy, Department of Geology, the authors extend their gratitude for help during the investigation. The authors also extend deepest thanks to J. A. Leadabrand, L. T. Norling and P. E. Mueller of the Portland Cement Association for their continuing highest cooperation and friendly counsel throughout the investigation. Members of the Engineering Experiment Station staff have of course contributed freely of time and effort during the investigation; outstanding among these have been Craig A. Lyon, who aided in field sampling and outlined the selection of sampling sites in northeastern Iowa, and T. Y. Chu, R. K. Katti and S. P. Sinha, who managed the testing of cured soil-cement cylinders during the author's several absences. Messrs. A. E. Wickstrom and J. B. Sheeler were of considerable assistance in the field sampling.

References Cited

1. Leadabrand, J. A., and Norling, L. T. Soil-cement test-data correlation in determining cement factors for sandy soils. Hwy. Res. Bd. Bul. 69: 29-44. 1953.
2. Leadabrand, J. A., Norling, L. T., and Hurless, A. C. Soil series as a basis for determining cement requirements for soil-cement construction. Paper presented at the Thirty-fifth Annual Meeting of the Highway Research Board, January 17-20, 1956. To be published either in a Bulletin or in the Proceedings.
3. Davidson, D. T., and Handy, R. L. Studies of the clay fraction of southwestern Iowa loess. Second National Conference on Clays and Clay Minerals, 1953. Clays and clay minerals: 190-208. Preprinted in Iowa Eng. Exp. Sta. Eng. Rept. No. 22. 1954.
4. ———. Property variations in the Peorian loess of southwestern Iowa. Iowa Acad. Sci. Proc. 59: 248-265. 1952.
5. Lyon, C. A., Handy, R. L., and Davidson, D. T. Property variations in the Wisconsin loess of east-central Iowa. Iowa Acad. Sci. Proc. 61: 291-312. 1954.
6. Lyon, C. A. Petrography of four northeastern Iowa loess samples. Unpublished M.S. thesis. Ames, Iowa, Iowa State College Library. 1955.
7. Scholtes, W. H., Ruhe, R. V., and Riecken, F. F. Use of the morphology of buried soil profiles in the Pleistocene of Iowa. Iowa Acad. Sci. Proc. 58: 295-306. 1951.
8. Simonson, R. W., Riecken, F. F., and Smith, G. D. Understanding Iowa soils. Dubuque Iowa, Wm. C. Brown Co. 1952.

9. Handy, R. L., Lyon, C. A., and Davidson, D. T. Comparisons of petrographic and engineering properties of loess in southwest, east-central and northeast Iowa. *Iowa Acad. Sci. Proc.* 62: 279-297. 1955.
10. American Association of State Highway Officials. Standard specifications for highway materials and methods of sampling and testing, Part I: Specifications. Washington, D. C., the Association. 1950.
11. Chu, T. Y., and Davidson, D. T. Simplified air-jet apparatus for mechanical analysis of soils. *Hwy. Res. Bd. Proc.* 32: 541-547. 1953.
12. American Society for Testing Materials. Procedures for testing soils. Philadelphia, the Society. 1950.
13. Portland Cement Association. Soil-cement laboratory handbook. Chicago, the Association. 1956.
14. U. S. Department of Agriculture. Soil survey manual. U.S.D.A. Handbook No. 18. Washington, D. C., the Department. 1951.
15. Eitel, Wilhelm. The physical chemistry of the silicates. Chicago, the University of Chicago Press. 1954.
16. Taber, Stephen. The mechanics of frost heaving. *Jour. Geol.* 38: 303-317. 1930.
17. Powers, T. C., and Helmuth, R. A. Theory of volume changes in hardened Portland-cement paste during freezing. *Hwy. Res. Bd. Proc.* 32: 285-297. 1953.
18. Rollins, Ralph. Movement of soil moisture under a thermal gradient. Unpublished Ph.D. thesis. Ames, Iowa, Iowa State College Library. 1954.
19. Winterkorn, Hans. The science of soil stabilization. *Hwy. Res. Bd. Bul.* 108: 1-24. 1955.
20. Grim, R. E. Clay mineralogy. New York, McGraw-Hill Book Co. 1953.
21. Grim, R. E., and Cuthbert, F. L. The bonding action of clays. Part I—clays in green molding sand. *Ill. Eng. Exp. Sta. Bul.* 357. 1945.
22. Handy, R. L., Davidson, D. T., and Chu, T. Y. Effect of petrographic variations of southwestern Iowa loess on stabilization with Portland cement. *Hwy. Res. Bd. Bul.* 98: 1-20. 1955. Reprinted in *Iowa Engr. Exp. Sta. Rept.* 22. 1954.
23. Handy, R. L. Stabilization of Iowa loess with portland cement. Unpublished Ph.D. thesis. Ames, Iowa, Iowa State College. 1956.

IOWA ENGINEERING EXPERIMENT STATION
 AMES, IOWA