

2000

An analysis of current instructional practices at selected universities utilizing interactive television technology

Richard Shengmao Chang
University of Northern Iowa

Let us know how access to this document benefits you

Copyright ©2000 Richard Shengmao Chang

Follow this and additional works at: <https://scholarworks.uni.edu/etd>



Part of the [Online and Distance Education Commons](#)

Recommended Citation

Chang, Richard Shengmao, "An analysis of current instructional practices at selected universities utilizing interactive television technology" (2000). *Dissertations and Theses @ UNI*. 746.

<https://scholarworks.uni.edu/etd/746>

This Open Access Dissertation is brought to you for free and open access by the Student Work at UNI ScholarWorks. It has been accepted for inclusion in Dissertations and Theses @ UNI by an authorized administrator of UNI ScholarWorks. For more information, please contact scholarworks@uni.edu.

Offensive Materials Statement: Materials located in UNI ScholarWorks come from a broad range of sources and time periods. Some of these materials may contain offensive stereotypes, ideas, visuals, or language.

INFORMATION TO USERS

This manuscript has been reproduced from the microfilm master. UMI films the text directly from the original or copy submitted. Thus, some thesis and dissertation copies are in typewriter face, while others may be from any type of computer printer.

The quality of this reproduction is dependent upon the quality of the copy submitted. Broken or indistinct print, colored or poor quality illustrations and photographs, print bleedthrough, substandard margins, and improper alignment can adversely affect reproduction.

In the unlikely event that the author did not send UMI a complete manuscript and there are missing pages, these will be noted. Also, if unauthorized copyright material had to be removed, a note will indicate the deletion.

Oversize materials (e.g., maps, drawings, charts) are reproduced by sectioning the original, beginning at the upper left-hand corner and continuing from left to right in equal sections with small overlaps.

Photographs included in the original manuscript have been reproduced xerographically in this copy. Higher quality 6" x 9" black and white photographic prints are available for any photographs or illustrations appearing in this copy for an additional charge. Contact UMI directly to order.

Bell & Howell Information and Learning
300 North Zeeb Road, Ann Arbor, MI 48106-1346 USA
800-521-0600

UMI[®]

AN ANALYSIS OF CURRENT INSTRUCTIONAL PRACTICES
AT SELECTED UNIVERSITIES
UTILIZING INTERACTIVE TELEVISION TECHNOLOGY

A Dissertation

Submitted

In Partial Fulfillment

of the Requirements for the Degree

Doctor of Industrial Technology

Approved:

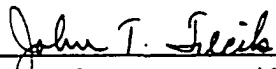

Dr. John T. Fecik, Chair

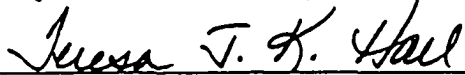

Dr. Teresa J. K. Hall, Co-Chair

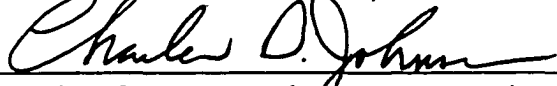

Dr. Charles D. Johnson, Committee Member

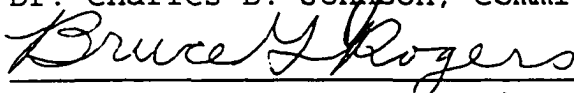

Dr. Bruce G. Rogers, Committee Member

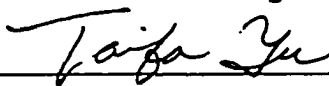

Dr. Taifa Yu, Committee Member

Richard Shengmao Chang

University of Northern Iowa

December 2000

UMI Number: 9992044

Copyright 2000 by
Chang, Richard Shengmao

All rights reserved.

UMI[®]

UMI Microform 9992044

Copyright 2001 by Bell & Howell Information and Learning Company.

All rights reserved. This microform edition is protected against
unauthorized copying under Title 17, United States Code.

Bell & Howell Information and Learning Company
300 North Zeeb Road
P.O. Box 1346
Ann Arbor, MI 48106-1346

Copyright by
Richard Shengmao Chang
2000
All Rights Reserved

AN ANALYSIS OF CURRENT INSTRUCTIONAL PRACTICES
AT SELECTED UNIVERSITIES
UTILIZING INTERACTIVE TELEVISION TECHNOLOGY

An Abstract of a Dissertation
Submitted
In Partial Fulfillment
of the Requirements for the Degree
Doctor of Industrial Technology

Approved:

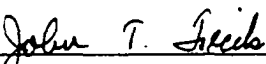

Dr. John T. Fecik, Committee Chair

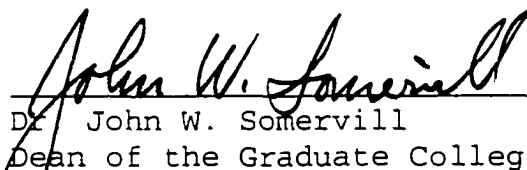

Dr. John W. Somervill
Dean of the Graduate College

Richard Shengmao Chang
University of Northern Iowa

December 2000

ABSTRACT

The problem approached in this study was to compare the teaching methods, classroom management, attitudes, and demographics toward Interactive Television (ITV) classes, which were developed in the University of Northern Iowa (UNI) and National Kaohsiung Normal University (NKNU) ITV programs.

The data were collected from UNI and NKNU ITV teachers and remote site students. Two-way ANOVA and Chi-Square tests were used to identify the differences between the two programs. The significant results are noted.

Both schools' ITV teachers clearly identified the objectives of the courses, presented materials in an organized way; and, effectively employed visual teaching aids, summarizing techniques, overhead cameras, Presentation software (e.g., Power Point), tests, lectures, demonstrations, and assignment discussions. Some ITV teachers had not yet used World Wide Web (WWW), Power Point, Interactive Study Guide (ISG), tests, problem-solving simulations, small group discussions, demonstrations, and reviewing techniques. In both ITV programs, instructional materials were provided in a timely manner, interaction between sites was frequent, and

appropriate pacing was conducted. The attitudes of all ITV teachers and students toward the ITV classes were positive, but they disliked some of the technical problems they encountered in production of the classes.

UNI ITV teachers used questioning techniques, problem-solving simulations, small-group discussion, and calling the student by name more effectively than the NKNU ITV teachers. UNI ITV students more actively participated than NKNU students did. UNI ITV teachers were more familiar with managing ITV sites than the NKNU ITV teachers. Communications between sites in NKNU ITV classes were more difficult than in UNI ITV classes. UNI ITV students liked that the ITV classes reduces their travel requirements. NKNU ITV students liked interaction. Many UNI ITV teachers attended ITV training sessions, but most NKNU ITV teachers had not been trained. Many UNI ITV participants were part-time graduate students, over 23 years old. In contrast, most participants of NKNU ITV program were full-time undergraduate students under 23 years of age.

Dedicated to

My father, Tian-shwen Chang

My mother, Mei-chi Chang-Shieh

And to

My wife, Li-pin Lee, and

My sons, Nai-wen Chang and Chi-wen Chang

for their love, support, and understanding of my study

ACKNOWLEDGEMENTS

The author would like to take the opportunity to express thanks and sincere appreciation to his advisor, Dr. John T. Fecik, co-advisor, Dr. Teresa J. K. Hall, and all the advisory committee members, Dr. Charles D. Johnson, Dr. Bruce G. Rogers, and Dr. Taifa Yu. Without their help, guidance, and support this dissertation would never have reached successful fruition.

The author would also like to express thanks to supporters Dr. Robert R. Hardman, and Dr. Terry D. Goro, for their offering information on the educational approach of Interactive Television.

Also, the author would like to thank his wife, Li-pin, sons, Nai-wen and Chi-wen, for their love and support during the time this study was conducted.

TABLE OF CONTENTS

| | PAGE |
|---|------|
| LIST OF TABLES | viii |
| LIST OF FIGURES | ix |
| CHAPTER I INTRODUCTION | 1 |
| Statement of Problem | 5 |
| Statement of Purpose | 5 |
| Statement of Need | 6 |
| Research Questions | 7 |
| Delimitation | 7 |
| Assumptions | 8 |
| Methods of Procedure | 8 |
| Methodology | 9 |
| Research Procedures | 12 |
| Definition of Terms | 12 |
| Description of Subsequent Chapters | 13 |
| CHAPTER II LITERATURE REVIEW | 14 |
| Distance Education | 14 |
| Terms of Distance Education | 14 |
| Definitions of Distance Education | 15 |
| Characteristics of Distance Education | 17 |
| The Evolution of Distance Education | 19 |
| A System View of Distance Education | 20 |
| Synchronous and Asynchronous Distance Learning | 22 |
| Technologies of Distance Education | 24 |
| Success Factors for Distance Education | 26 |
| Attitudes Toward Distance Education | 28 |
| Teaching in ITV Classes | 29 |
| The Role of the Teacher in Distance Education | 29 |
| Teaching Competencies | 30 |
| Teaching Methods | 31 |
| Classroom Management | 36 |
| Time Management | 36 |
| Behavior Management | 37 |
| Instructional Management | 39 |

| | PAGE |
|---|--------|
| Improving Teaching | 43 |
| Interactive Teaching | 47 |
| Interactive Television | 47 |
| Evolution of Interactive Television | 48 |
| ITV Classroom Equipment | 49 |
| ITV Attributes | 50 |
| Survey | 50 |
| Questionnaire and Interview | 51 |
| Likert Scale | 55 |
| Validity of the Instrument | 55 |
| Summary | 56 |
| CHAPTER III METHODOLOGY | 58 |
| Identification of the Accessible Population | 58 |
| Sampling Methods | 59 |
| Preparation of the Survey Instrument | 60 |
| Development of the Questionnaires | 60 |
| Structure of the Questionnaires | 61 |
| Validity of the Instrument | 62 |
| Collection of Data | 63 |
| Analysis of the Data | 65 |
| CHAPTER IV DATA PRESENTATION AND FINDINGS | 67 |
| Description of Responses | 67 |
| Research Question 1 | 70 |
| Research Question 2 | 75 |
| Research Question 3 | 76 |
| Research Question 4 | 79 |
| Summary | 85 |
| CHAPTER V SUMMARY, CONCLUSIONS, AND RECOMMENDATIONS ... | 86 |
| Summary of Study | 86 |
| Summary of Findings | 89 |
| Discussions and Conclusions | 93 |
| ITV Teaching Methods | 93 |
| ITV Classroom Management | 97 |
| Attitudes Toward ITV Classes | 99 |
| Demographics | 100 |

| | PAGE |
|---|------|
| Recommendations | 102 |
| Recommendations for UNI ITV Program | 103 |
| Recommendations for NKNU ITV Program | 103 |
| Recommendations for Future Study | 104 |
| REFERENCES | 106 |
| APPENDIX A: Definition of Terms | 116 |
| APPENDIX B: Experts Information | 124 |
| APPENDIX C: Permission for Human Subjects | 126 |
| APPENDIX D: Request UNI ITV Teachers and Students for Participating Research | 128 |
| APPENDIX E: ITV Program Teacher Questionnaire | 130 |
| APPENDIX F: ITV Program Student Questionnaire | 135 |
| APPENDIX G: Note for Receiving A Summary of Study Results | 139 |
| APPENDIX H: (Chinese Version) Request NKNU ITV program Teachers and Students for Participating Research | 141 |
| APPENDIX I: (Chinese Version) ITV Program Teacher Questionnaire | 143 |
| APPENDIX J: (Chinese Version) ITV Program Student Questionnaire | 147 |
| APPENDIX K: (Chinese Version) Note for Receiving A Summary of Study Results | 151 |
| APPENDIX L: Descriptive and Inferential Statistical Data of Each Question of Questionnaire Part I: ITV Teaching Methods | 153 |

| | PAGE |
|---|------|
| APPENDIX M: Descriptive and Inferential Statistical Data of Each Question of Questionnaire Part II: ITV Classroom Management | 171 |
| APPENDIX N: Descriptive and Inferential Statistical Data of Each Question of Questionnaire Part III: Attitudes Toward ITV Classes ... | 179 |
| APPENDIX O: One Thing That You Like Best about ITV Classes | 184 |
| APPENDIX P: One Thing That You Dislike Most about ITV Classes | 188 |
| APPENDIX Q: Comments about ITV Classes | 194 |
| APPENDIX R: Titles of UNI ITV Courses Offered Before Spring semester 2000 | 199 |
| APPENDIX S: Titles of NKNU ITV program Courses Offered Before Spring semester 2000 | 202 |
| APPENDIX T: A Brief List of Similarities and Difference between UNI and NKNU ITV Programs | 204 |

LIST OF TABLES

| TABLE | PAGE |
|---|------|
| 1. A List of Distance Delivery Subsystems | 23 |
| 2. Comparison of Teacher-Centered and Student-Centered Methodology | 32 |
| 3. Instructional Methods and Their Strengths | 35 |
| 4. Questionnaire Mailing and Response | 69 |
| 5. Comparison of Percentages of two School Respondents Answering "Not Used" | 71 |
| 6. School Factor Data for Those Questionnaire Items Showing Statistical Significant Differences at the .05 Level | 72 |
| 7. School Factor Data for Those Questionnaire Items Showing No Statistical Significant Differences at the .05 Level | 73 |
| 8. Demographic Information of Teacher Respondents of UNI and NKNU ITV Programs | 81 |
| 9. Demographic Information of Student Respondents of UNI and NKNU ITV Programs | 84 |

LIST OF FIGURES

| FIGURE | PAGE |
|---|------|
| 1. The Evolution of Distance Education | 20 |
| 2. A System Model for Distance Education | 21 |
| 3. Basic Seven-Step Planning Process | 41 |
| 4. The Teaching Process Model | 42 |
| 5. An Example of ISG | 45 |
| 6. ISG Display on TV Screen | 46 |
| 7. An Example of a Word Picture | 46 |
| 8. Flowchart in Conducting a Questionnaire Survey ... | 53 |
| 9. Likert Scale | 55 |
| 10. The Population of Four Groups | 59 |
| 11. The Samples of Four Groups | 60 |

CHAPTER I

INTRODUCTION

The goal of distance education is to offer students living in remote areas with limited educational access an experience that is as much as possible like that of traditional, face-to-face instruction (Schlosser & Anderson, 1994). Advancements in information technology and telecommunication systems over the last 10 years has made it possible to transmit classes and instruction to such remote students. Virtual electronic classrooms, live two-way audio/video teleconferencing, and live two-way, full-motion, interactive television (ITV) systems have created a virtual long-distance, face-to-face teaching experience (Keegan, 1996).

Many programs in the United States and Taiwan have gradually increased distance education opportunities. Two specific cases include the University of Northern Iowa (UNI) ITV program via the Iowa Communication Network (ICN), and the National Kaohsiung Normal University (NKNNU) ITV program via the Taiwan distance learning network. Both programs have created opportunities for students to access virtual face-to-face interactive instruction.

The ICN began operation in 1993. It is a statewide, state-administered fiber optic telecommunication network designed to transport high quality two-way, full-motion, interactive video, data and audio signals. ICN connects each site in Iowa's 99 counties linking colleges, universities, secondary schools, regional libraries, and governmental agencies (Goro, 1995; Iowa Database, 1999; Olson & Hall, 1997; Simonson, 1994; Simonson & Schlosser, 1995).

The Taiwan distance learning network links universities, colleges, government agencies, high schools, and elementary schools in 23 counties and cities (Ma, 1997). The Taiwan distance learning network is a fiber optic telecommunication network. Like the ICN, it is responsible for the transmission of two-way, full-motion, interactive video; long distance voice communications; and data transport.

The NKNU ITV program began in 1997 in collaboration with other colleges and universities as both an origination site and a remote site. Students may enroll in any courses offered by the universities and colleges in the ITV programs. Schools collaborating with NKNU ITV program have included National Cheng Kung University, National Sun Yat-

Sen University, I-Shou University, National Kaohsiung First University of Science and Technology, National Kaohsiung Institute of Technology, and Kaohsiung Medical University, etc.

The Clinton-Gore Administration launched the National Information Infrastructure (NII) in 1993 in the U.S., enhancing distance education development. NII provided an uninterrupted web of communications linking computers, databases, and all telecommunication technologies. Users can access e-mail, forums, videoconferencing, on-line discussion, on-line libraries, interactive TV, video-on-demand, and the World Wide Web (WWW) for distance education. That is electronically connected. It is possible for this system to reach any home, school, and workplace in the United States (Brown, 1993; Nasseh, 1996; Yang, 1996).

Similarly, in Taiwan, the Ministry of Education of the Republic of China planned a four-year, distance learning development program, which began in 1997. The goals of this four-year development program have been to: (a) establish a super information highway network, select courses from various schools, and cooperate with international schools to establish a global learning

environment; (b) share foreign techniques and develop teaching materials for distance learning; (c) establish a united distance learning center and develop distance training for in-service teachers, enterprise employees, and government employees; (d) educate and train distance learning professional in planning, teaching, engineering technique, and teaching material design; and (e) encourage private companies to establish learning materials on the Internet for elementary and high school courses. Once these goals were fulfilled, students would be able to study various subjects from multiple environments (Ministry of Education, 1996; Yin, 1999).

Distance education has evolved from correspondence study, begun 100 years ago (Garrison, 1989), to the present virtual face-to-face classroom teaching and learning system. Teacher-centered strategies and methods of instruction have changed to those which are more student-centered, and from passive to active learning. Egan and Gibb (1997) noted that "several prominent researchers and practitioners have provided recommendations for moving students from passive to active learning habits" (p. 37). Clear and understandable student-centered instruction responds to students' explicit communication and learning

needs and provides learners with timely feedback. Currently, telecourse instructors need to create detailed syllabi and interactive study guides, which are more specific in content than those used in more traditional classes (Egan & Gibb, 1997). Instructors have experienced teaching strategies and classroom management techniques in varying environments in the past. As distance education evolves, instructors could face new challenges in teaching methods and classroom management.

Statement of Problem

The intent of this study was to investigate and compare teaching methods and classroom management practices in university ITV courses in two selected countries, and also to compare the attitudes toward ITV programming and demographics of teachers and students participating in these two ITV programs.

Statement of Purpose

The purpose of this study was to compare and contrast the development of University of Northern Iowa (UNI) and National Kaohsiung Normal University (NKNU) ITV programs in ITV teaching methods, ITV classroom management, attitudes toward ITV classes, and demographics of ITV teachers and students, in order to determine improvements and direction.

Statement of Need

The following citations and reasons stated the needs of this study. Wheeler, Batchelder, and Hampshire (1996) indicated that "in order to better understand the pedagogical implications of television as a medium for instruction, it is important that we examine current instructional practices and elicit the perspectives of the participants in instructional television courses" (p. 172).

Barker and Dickson (1996) noted that "rapid technological developments of the past decade have made possible an array of technological tools that can profoundly change today's classrooms and reform education" (p. 19). Office of Technology Assessment (1989) indicated that "old styles of teaching may not be appropriate or effective" (p. 87). These writers have noted the changes and direction of technology development. At present, most distance learning systems combine several technologies. For example, the ITV systems combine satellite, fiber optic, microwave, and cable. ITV classrooms are also able to incorporate newly augmented kinds of technologies, such as computers, videocassette players/recorders (VCR), video cameras, microphones, sliders, television monitors, etc. (Barker & Dickson, 1996; Chavkin, Kennedy, & Carter, 1994;

Hardman, 1999; Office of Technology Assessment, 1989). However, to investigate the teaching methods of using new technologies and examine the ITV classroom management was important for developing the ITV programs. Therefore, this study was needed.

Research Questions

The following research questions were developed to address the research problem:

1. What are the similarities and/or differences in the teaching methods used in the UNI and NKNU ITV programs?
2. What are the similarities and/or differences between classroom management practices in the UNI and NKNU ITV programs?
3. What are the similarities and/or differences in teacher and student attitudes toward UNI and NKNU ITV programming?
4. What are the similarities and/or differences in teacher and student demographics of the UNI and NKNU ITV programs?

Delimitation

The study was delimited to the following:

1. Participants were delimited to teachers and remote site students involved in UNI and NKNU ITV programs.

2. Samples were delimited to four disparate groups, two at each university: (a) the teachers who have teaching experience with ITV courses; (b) the students who have direct learning experience with ITV courses.

3. Valid samples were delimited to all those who voluntarily participated, completed, and returned questionnaires by mail.

4. The variables in this study were restricted to teaching methods, classroom management, attitudes, and demographics.

Assumptions

The following assumptions were made in this study:

1. The participants could correctly interpret the questions and items.

2. The participants answered the questions and items accurately and truthfully.

3. The participants in the study were representative the population involved with ITV distance education.

Methods of Procedure

This study was a descriptive and inferential study. The methods of procedure were developed and incorporated methodology and the sequence in accomplishing research.

Methodology

The research was conducted by a survey. The methodology included identifying the population, applying a sampling method, designing a survey instrument, conducting content-related validity evidence, collecting data, and analyzing the data.

Population

The population examined in this study consisted of four groups. Group one was the teachers of the UNI ITV program. Group two was the students who had learning experiences in UNI ITV program, for the fall semester, 1999. Group three was the teachers of the NKNU ITV program. Group four was the students who had learning experiences in the NKNU ITV program, for the fall semester, 1999.

Sample

The group one samples were 40 teachers who had taught courses in the UNI ITV program. The group two samples consisted of 300 students who came from the UNI ITV program. The group three samples were 40 teachers who had taught a course in the NKNU ITV program. The group four samples were 300 students who came from the NKNU ITV

program. All the students enrolled at least in an ITV course at the remote site in fall semester, 1999.

Instrument

Two kinds of questionnaires were mailed to the sample students and teachers to collect the necessary information and data.

Components of the questionnaires were selected and adapted from previous research instruments and were structured to derive data related to the following questions which were related to the Research Question 1, 2, and 3:

1. What are the teaching methods used in ITV programs?
2. What are the classroom management techniques used in ITV programs?
3. What are the attitudes of teachers and students toward ITV classes?

Content-Related Validity Evidence

A content-related validity test could support research evidence about the validity of the targeted data (Fraenkel & Wallen, 1996). The researcher consulted experts and conducted a pilot-test to validate the survey. The questionnaire was revised according to results found

after conducting the pilot-test and after consulting with experts who had experiences in ITV classes.

Data Collection

The final version of the questionnaire was mailed to the targeted participants, enclosed with a cover letter explaining the survey, along with a return address and a stamped envelope. In three weeks, follow-up questionnaires were sent to the participants in order to achieve a good response rate (Babbie, 1990; Hittleman & Simon, 1997).

Data Analysis

The data from the questionnaire were analyzed using the following selected statistical methods:

1. Frequency distributions of the demographic data were reported.

2. The responses of every question were processed to produce the mean score.

3. Two-way ANOVA and Chi-Square tests were used to determine the statistical significance between the mean scores or the percentages of the two universities' independent targeted groups at the .05 level of critical value (Hurlburt, 1998; Lin, 1993). Statistical data were used to identify any significant differences between UNI and NKNU ITV programs.

Research Procedures

The research procedures used to structure this study were as follows:

1. The problem, purpose, needs, research questions, delimitation, and assumptions were stated.
2. The literature was reviewed.
3. The methodology, including the procedure of methodology was outlined.
4. A valid and reliable questionnaire was developed.
5. The survey was conducted.
6. The data were collected.
7. The scores were processed.
8. The data and findings were analyzed.
9. A summary, conclusion, and recommendations for further study were offered.

Definition of Terms

The following terms are defined to clarify their use in the context of this study: Attitude, Classroom Management, Document Camera, Fiber Optics, Integrated Services Digital Network (ISDN), Interactive Study Guide (ISG), Interactive Television (ITV), Iowa Communication Network (ICN), Instructional Television Fixed Service (ITFS), National Kaohsiung Normal University ITV program,

Origination Site, Overhead Camera, Remote Site, Similarity, T-1 Line, T-3 Line, Teaching Method, and Traditional Class (see Appendix A).

Description of Subsequent Chapters

Chapter Two reviewed the literature related to distance education, teaching, interactive television, and survey. For example, definitions of distance education, attitude toward distance education, teaching methods, classroom management, ITV classroom equipment, and conducting a questionnaire survey were reviewed.

Chapter Three presented a detailed description of the research procedures and methods used in this study, including identification of the population, preparation of the instrument, development of the questionnaire, validity of the instrument, and collection and analysis of the data.

In Chapter Four, the reports and the findings of the collected and the analyzed data are presented and described. Such data and findings provide the necessary information to guide the reader to the conclusions and recommendations of the study.

Chapter Five includes the summary, conclusion, and recommendations based on the research problem, literature review, data, and findings.

CHAPTER II

LITERATURE REVIEW

This literature review concentrated on four sections: (a) distance education, (b) teaching in ITV classes, (c) interactive television, and (d) a survey.

Distance Education

In this section, the researcher reviewed those areas related to distance education: terms, definitions, characteristics, evolution, a system view, synchronous and asynchronous distance learning, technologies, success factors, and users' attitudes.

Terms of Distance Education

The term "distance education" included "distance teaching" and "distance learning," which were parts of the teaching and learning processes. Distance education emphasized the instruction between the instructor and learner. Distance teaching addressed management and instructional design activities, and stressed the instructor's responsibilities. Distance learning emphasized the activities of the learner, and focused on the learner's role (Suave, 1993; Verduin & Clark, 1991). However, Moore and Kearsley (1996) said that many people used the term "distance learning" as a synonym for distance

education, because distance education aims to provide instruction in places and times that are convenient for learners rather than teachers. Recently, a new term, "distributed education," has become a popular phrase to describe programs where courses are taught online and in collaboration to encourage virtual interaction among students in the same course (Connick, 1999).

Definitions of Distance Education

Definitions of distance education provided by Peters and Moore (cited in Keegan, 1996), and Rumble (1989) are based on an analysis of correspondence study that is mostly one-way delivery with limited interaction. Peters' definition stresses three concepts: mass education, industrialization, and the use of a technical medium (Keegan, 1996). Moore's definition expanded the use of communication technology that is facilitated by print, electronic, mechanical or other devices between teacher and learner (Keegan, 1996). Rumble's (1989) four-part definition included the following: (a) The elements of education are teacher, students, a course, and a contract between the student and the teacher or institution; (b) Student and teacher are separated; (c) Student and institution are separated; (d) Teaching and learning

involve two-way communication; and learning takes place in the absence of the teacher. Keegan (1996) noted six basic defining elements of distance education:

1. The separation of teacher and learner that distinguishes it from face-to-face lecturing;
 2. The influence of an educational organization that distinguishes it from private study;
 3. The use of technical media, usually print, to unite teacher and learner and carry the educational content;
 4. The provision of two-way communication so that the student may benefit from or even initiate dialogue;
 5. The possibility of occasional meetings for both didactic and socialization purposes; and
 6. The participation in an industrialized form of education, which, if accepted, contains the genus of radical separation of distance education from other forms within the educational spectrum.
- (p. 44)

Definitions of distance education reflect existing technologies. As new technologies emerged, definitions of distance education changed to reflect the capabilities of the technology. Early definitions were based on correspondence study which was limiting in interaction capabilities. However, more recent technological innovations have influenced a different interpretation of distance education and focused on the interaction of students and teacher (Suave, 1993). Therefore, based on the concept of virtual electronic classrooms, Simonson and

Schlosser (1995) suggested the following redefinition of distance education:

Distance implies formal institutionally-based educational activities where the teacher and learner are normally separated from each other in location, but not normally separated in time, and where two-way interactive telecommunication systems are used for sharing video, data, and voice instruction. (p. 13)

The development of information and telecommunications interactive technologies has resulted in many terms used to describe distance education including: web-based training, web-based learning, web-based teaching, telecommunications-based education, teletraining, telelearning, teleteaching (Hefzallah, 1999). Hefzallah (1999) explains:

Distance education is an educational system for providing instruction at the command of the students at times and places more convenient to them than being physically present in a regular classroom setting. In some delivery modes of distance education, interaction between the instructor and the students happens in real time. (p. 246)

Characteristics of Distance Education

While reviewing the literature and analyzing the definitions provided by many scholars, the following characteristics of distance education were located.

As a composite definition, distance education is a method of instruction in which the learner is geographically separated from the teacher, thus

distinguishing it from face-to-face lecturing (Hefzallah, 1999; Heinich, Molenda, Russell, & Smaldino, 1999; Keegan, 1996; Peters, 1993; Rumble, 1989; Simonson & Schlosser, 1995; Suave, 1993).

Based on the concept of the virtual electronic classroom, the teacher and learner are normally separated from each other by location, but not normally separated in time. The teaching/learning process still occurs simultaneously. It is contiguous in time; thereby, permitting immediate response to student inquiries and comments. The teacher can see, hear and dialogue with students who are far away from the origination site. At the same time students at all sites can see, hear and dialogue with each other. They can virtually interact face-to-face at a distance (Barker, Frisbie, & Patrick, 1989; Keegan, 1983, 1996; Simonson & Schlosser, 1995).

In correspondence-based distance education, communication occurs non-contiguously; information is delivered by mail (Garrison & Shale, 1987).

Telecommunication-based distance education uses technological media to unite teacher and learner, carry the educational content, and deliver the distance courses

(Dede, 1996; Garrison & Shale, 1987; Heinich et al., 1999; Keegan, 1996; Moore, 1990).

Distance education uses fiber optic, microwave, or satellite electronic systems through live television to connect teacher and students. The system can be one- or two-way video and two-way audio, or in a packaged format using audio-tape, videotape, or CD-ROM (Chen, 1997; Cyr, 1989; Heinich et al., 1999; Mitchasson, 1997; Moore, Thompson, Quigley, Clark, & Goff, 1990; Simonson & Schlosser, 1995).

The Evolution of Distance Education

Moore and Kearsley (1996) said that distance education had evolved over a number of generations (see Figure 1). The first generation involved correspondence study; the second began with the appearance of the first Open University in the early 1970s. The third followed with computer-based education in the 1990s.

Correspondence study consisted of printed materials with written essays and assignments being sent to the learners by mail. Most current courses of distance education at the college level are conducted through such correspondence. Open universities used broadcast and recorded media, especially programs distributed by radio,

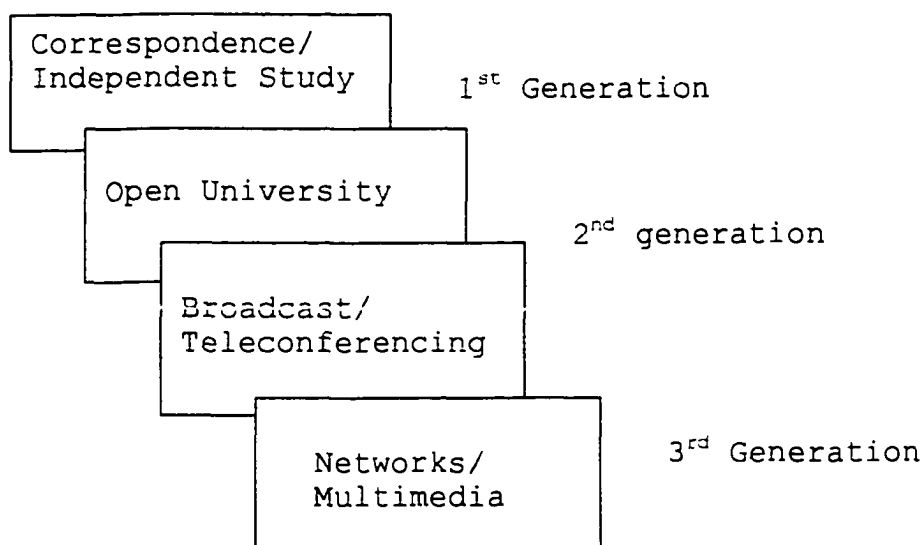

Figure 1. The Evolution of Distance Education

Note. From Distance Education: A Systems View (p. 20) by M. G. Moore and G. Kearsley, 1996, Belmont, CA: Wadsworth Publishing Company.

television, and audio-tape, but still relied on correspondence instruction. They also employed telephone, satellite, cable, or ISDN (Integrated Service Digital Network) lines for delivery and interaction (Moore & Kearsley, 1996). Computer-based courses deliver information by CD-ROM disks, Internet, and the World Wide Web (Kommers, Grabinger, & Dunlap, 1996).

A System View of Distance Education

Moore and Kearsley (1996) stated that distance education was a system which consists of history, institutional philosophy, learning, teaching, communication, design, and management (see Figure 2).

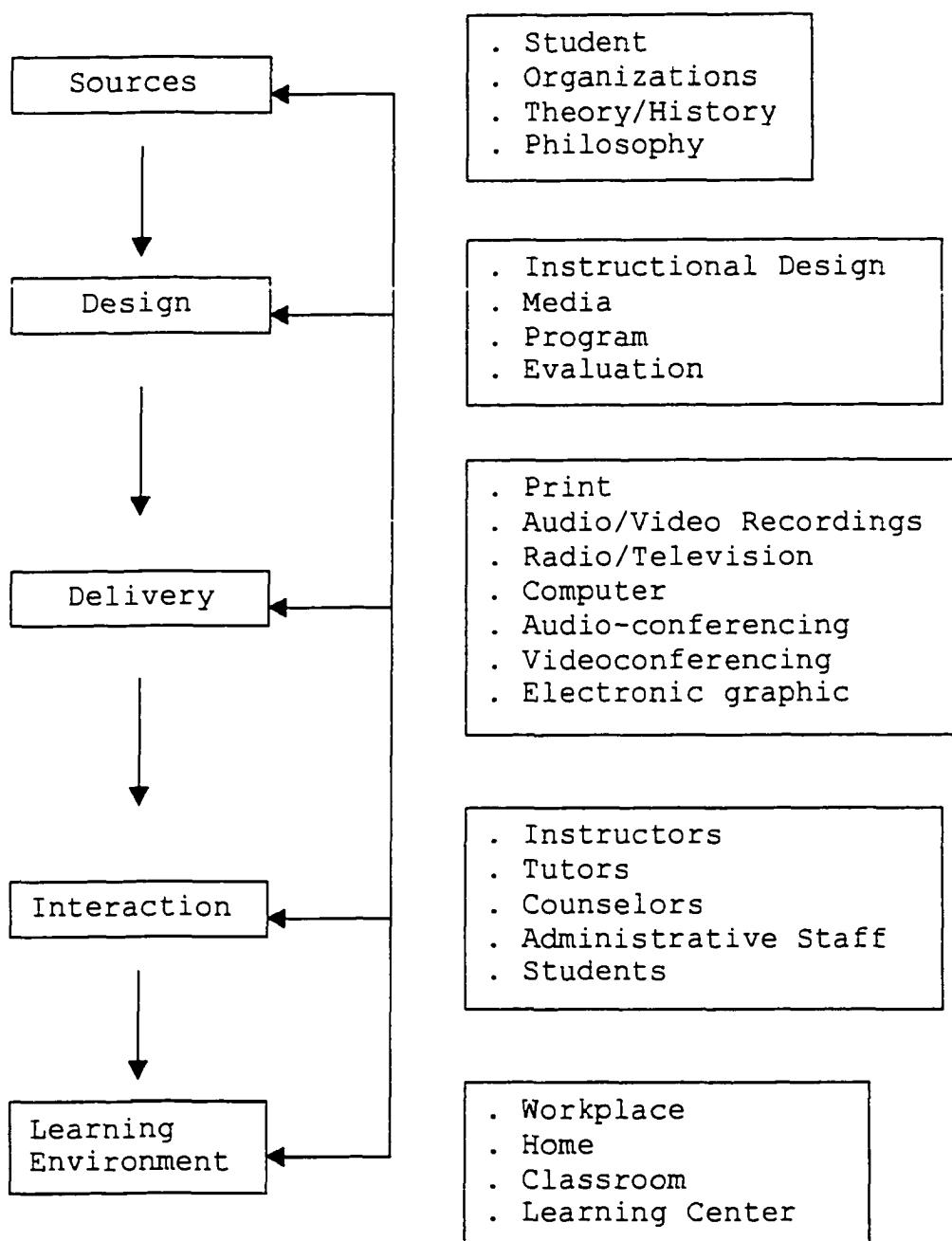

Figure 2. A Systems Model for Distance Education

Note. From Distance Education: A Systems View (p. 9) by M. G. Moore and G. Kearsley, 1996, Belmont, CA: Wadsworth Publishing Company.

Subsystems within these main components link to the other subsystems to form the total system. When these systems are applied, the majority of distance education sources are integrated. For example, all parts of the courses are carefully planned and designed to fit with the others; the technologies are employed in harmony with each other.

Chen (1997) stated that there had been tremendous technological advancement in distance delivery subsystems. A wide range of technological delivery subsystems is available to be used alone or in combination with other technologies. Table 1 illustrates the various systems, media technologies, and delivery modes.

Synchronous and Asynchronous Distance Learning

Distance learning can be approached in two systems of time: One is synchronous learning; the other is asynchronous learning. In synchronous learning the teacher instructs and students learn communication at the same time emphasizing a simultaneous group learning experience. Teacher and students communicate in real time. Both teacher and students must attend class at a specified time and place. In asynchronous learning (e.g., Internet and WWW courses) the teacher instructs and students learn communication at different times. Students are offered a

Table 1

A List of Distance Delivery Subsystems

| Systems | Media | Delivery Mode |
|------------------------|---|--|
| Print | Print Material (programmed instruction guide lessons) | Mail |
| Audio | Audio cassette | Mail |
| | Radio Broadcast | Radio Transmission |
| | Interactive Audio | |
| | Teleconferencing | Operator Assisted |
| Electronic Graphics | Electronic Board | Telephone Lines |
| | Fax | Telephone Lines |
| Video | Instructional Television | |
| | Fixed Service (ITFS) | Microwave |
| | Interactive TV; | |
| | Video Conferencing | Microwave Cable; T-1 Line; T-3 Line; Fiber Optics; Satellite |
| | Video Tape | Mail |
| | Video disc | Mail |
| Computer | Computer-assisted Instruction; Floppy; CD-ROM | Mail |
| | E-mail Conferencing; | |
| | Bulletin Boards System | Telephone Lines; T-1 Line; T-3 Line; Fiber Optics |
| | Internet; WWW; Digital Video Conferencing | Telephone Lines; T-1 Line; T-3 Line; Fiber Optics |

Note. From "Distance Delivery Systems in Terms of Pedagogical Considerations: A Reevaluation," By L. L. Chen, 1997, Educational Technology, 37(4), 34-37.

choice of time, place (e.g., at home) and activities (e.g., using CD-ROM); students send their completed work to the teacher for evaluation via e-mail, Fax, or mail (Connick, 1999; Herring & Smaldino, 1998; Keegan, 1995). In this study, synchronous learning was used for ITV classes.

Technologies of Distance Education

Learners and instructors in various locations can interact by telephone in audio-conferencing instruction. Instruction is delivered through discussions and lectures. Most materials are distributed by the instructor in advance and reviewed by learners before the conference. Sometimes, they use Fax (Ludlow & Duff, 1998), but most assignments and examinations are exchanged by mail. Audio-conferencing is an example of the synchronous delivery system. It places no constraints on location, but requires learners to interact at a scheduled time. The disadvantages are that learners can not see each other, nor use visual media (Ludlow & Duff, 1998).

Broadcast television delivers courses by sending digital audio and video signals by microwave relay over short distances, or by satellite over longer distances (Zigerell, 1991). Microwave systems transmit video signals by means of relay towers stationed at approximately 30-mile

intervals. Satellite systems up-link the signals to the satellite, then down-link them to multiple sites. Broadcast television displays clear and detailed one-way video and audio presentations. Audio-conferencing often accompanies television allowing interactions between the instructor and learners. It is a synchronous system that restricts learners to equipped places and scheduled times (Ludlow & Duff, 1998).

Compressed video systems are synchronous and employ fiber optic or coaxial telephone lines to transmit two-way audio and video signals in distance education (Duran & Sauer, 1997). Compressed video allows instructors and learners to see and hear each other. However, compressed video has limited bandwidth for transmission and the effects of compression often result in distorted picture and sound quality.

The compressed video transmission system requires special equipment at each site. The home site must have a coding device to encode and decode the video and audio signals as well as pay fees to the telephone company for use of ISDN lines (Ludlow & Duff, 1998).

Computer multimedia modules use CD-ROM disks to transmit courses using a number of instructional materials,

including text, audio, and video. Learners also may use these to engage in independent study. The program designer must have considerable expertise in computer programming along with the time and energy to produce the modules. Learners must have access to personal computers with CD-ROM players (Ludlow & Duff, 1998).

Online instruction utilizes the Internet and the World Wide Web. The instructor posts text, audio, and video materials to a site that can be accessed on demand by learners. Sometimes instructors provide opportunities for interaction through e-mail, bulletin board system (BBS), or live chat rooms. Web-based instruction requires teacher knowledge of hypertext markup language (HTML). Learners must have access to a computer with telephone modem and web browser software (Ludlow & Duff, 1998).

Success Factors for Distance Education

Wagner (1995) said that programs and services were critical to the success of distance education. Several principal players hold the key to distance education program success: instructors who teach at a distance; learners pursuing distance educational courses and programs; site facilitators coordinating distance learning environments; and administrators responsible for managing

distance learning courses, programs, staff, and technologies.

Wagner (1995) identified a number of factors necessary for affecting distance teaching/learning success: audience analysis, instructional design, course selection, course reconfiguration, lesson planning, interactive instructional strategies, instructional delivery systems, media and materials adaptation for distance delivery, development of effective graphics, facilitators at distance education sites, learner and instructor support services, and program evaluation and learner assessment.

Wagner (1995) noted that any evaluation in distance learning should consider: (a) cognitive, affective, and psychomotor outcomes of the educational experience; (b) attitudes toward distance learning programs and courses; (c) effectiveness of technologies for various teaching/learning tasks; (d) effectiveness of teaching techniques and models of teaching; (e) comparative methods of tracking learner performance; (f) instructor evaluation; (g) effectiveness of test techniques; (h) technology system reliability; and (i) cost-benefit determinations.

Attitudes Toward Distance Education

Hanson et al. (1996) noted that "positive attitudes were found in students at remote sites of an interactive television class" (p. 24). Schlosser and Anderson (1994) indicated that "students had a generally positive attitude toward both compressed video technology as a method of instruction delivery, as well as opportunities for interaction provided by the system" (p. 27). Hanson et al. also pointed out that "attitudes of students in a distance learning program related to their academic success" (p.25). Sullivan (1998) stated that "student attitudes toward the technology medium may represent a means of improving student academic success in a distance education setting" (p. 4). According to the above findings, students' attitudes toward distance education will influence their learning. Students with positive attitudes toward distance education were likely to be successful.

The Office of Technology Assessment (1989) indicated that "teacher attitudes were generally favorable toward ITV; 75 percent said they would choose to teach again on the system" (p. 47). Walsh (1993) pointed out that the attitudes of teachers toward distance education would

affect their willingness to teach a distance course. This indicates teachers' attitudes influence their teaching.

Teaching in ITV Classes

In this section, the researcher reviewed the role of the teacher in distance education, teaching competencies, teaching methods, classroom management, teaching improvement, and interactive teaching.

The Role of the Teacher in Distance Education

The Office of Technology Assessment (1989) stated that the teacher was the key to success in distance learning. If the teacher is good, the technology becomes almost transparent; if not, no technology can overcome poor teaching.

The role of the teacher in the distance learning environment was succinctly defined by the Office of Technology Assessment (1989):

The critical role of teachers in effective learning means that all must have training, preparation, and institutional support to successfully teach with technology. Distance learning has dual impacts on teachers: as a tool for teaching and as a means to upgrade their own skills and professional development. (p. 11)

Though the teacher's role is very important, few teachers have had experiences or training to successfully use technology in their classroom and to become an

effective distance teacher (Office of Technology Assessment, 1989).

Park and Monson (1980) state that the techniques of teaching were humanization, participation, message style, and feedback. Addressing participants by name is an example of easily humanizing the students. Site-to-site discussion and buzz groups can encourage active participation. Short instructional segments, visual aids, and varying tone of voice and volume are message styles which enhance students' interest and keep their attention. Exams, questionnaires, interviews, or group reports can obtain the right feedback.

Teaching Competencies

Teaching competencies related to live interactive television programming requires instructors to: (a) plan and organize the interactive television course, (b) design television graphics and visualize thinking, (c) involve students at field sites and manage their learning activities, (d) design interactive study guide and handout correlated with the television screen, (e) possess verbal and nonverbal presentation skills, (f) make sure they have a good appearance for the television screen, (g) work as part of a team, (h) prepare questioning strategies, (i)

possess expertise in their subject matter, and (j) have technology operation skills (Cyrs, 1997; Cyrs & Conway 1997; Thach, 1994).

Teaching Methods

One of the important instructional strategies for teachers to consider is the methods they will use. Moore (1998) stated that teaching methods should be related to the goals, specific learning objectives, and content of the course. The method should capture the attention of students and to involve them as much as possible in the learning situation. Moore also pointed out, "There are two basic instructional types: teacher-centered and student-centered" (p. 118). Teacher-centered instructional approaches are those in which students acquire knowledge by listening to the teacher, reading a textbook, or both. In such an approach the student is a passive recipient of information. Student-centered instructional approaches require that teachers provide a learning environment, invite students to actively participate and help students to shape their own learning experiences. These two instructional approaches can be used effectively to achieve educational goals. Comparisons of these two methods of instruction are presented in Table 2.

Table 2

Comparison of Teacher-Centered and Student-Centered Methodology

| Method | Amount of Teacher Control | Intent and Unique Features |
|--|---------------------------|--|
| Teacher-Centered Instructional Approaches | | |
| Lecture | High | Telling technique. Teacher presents information without student interaction. |
| Lecture-recitation | High to moderate | Telling technique. Teacher presents information and follows up with question-and-answer sessions. |
| Socratic | Moderate | Interaction technique. Teacher uses question-driven dialogues to draw out information from students. |
| Demonstration | High to Moderate | Showing technique. Individual stands before class, showing something, and talks about it. |
| Modeling | High | Showing technique. Teacher models desired student behaviors. Students learn by copying actions of model. |
| Student-Centered Instructional Approaches | | |
| Discussion | Low to moderate | Interaction technique. Whole class or small group interact on topic. |
| Panel | Low | Telling technique. Group of students present and/or discuss information. |
| Debate | Low | Telling technique. Competitive discussion of topic between teams of students. |
| Role playing | Low | Doing technique. Acting out of roles or situations. |
| Cooperative learning | Low | Doing technique. Students work together in mixed-ability group on one or more tasks. |
| Discovery | Low to moderate | Doing technique. Students follow established procedure in an attempt to solve problems through direct experiences. |
| Inquiry | Low | Doing technique. Students establish their own procedure for solving a problem through direct experiences. |
| Games, Simulations | Low | Doing technique. Involvement in an artificial but representative situation or event. |

Note. From Classroom Teaching Skills (4th ed., pp. 119-120) by K. D. Moore, 1998, Boston: McGraw-Hill Companies, Inc.

Stephens (1994) divided teaching methods into three broad categories: expository, direction, and discovery. Expository methods are those in which teachers present the content to learners using lectures or talks; combine lectures or talks with learner participation, or provide a demonstration. Direction methods require teachers to organize and structure a program for learners to arrive at a set of predetermined objectives using discussion, group tasks and activities, skills practice, brainstorming, buzz groups, question and answer sessions, role playing, and field trips. Discovery methods are those in which learners pursue a process of intellectual exploration using self-directed learning, gaming, and simulation.

Froyen and Iverson (1999) stated that there were two categories of teaching methods: direct and indirect teaching. Direct teaching methods emphasize teacher control of the educational process. The teacher predetermines the objectives and all students use the same materials: textbooks and assignments, and evaluation are standardized. Indirect teaching methods emphasize process over product and focus on eliciting student participation and contribute to divergent rather than convergent production. The teacher becomes a facilitator who does not

attempt to impart or impose his/her knowledge or serve as a director of learning.

Froyen and Iverson (1999) stated that Charles identified 11 methods of teaching in 1983. The first five methods are typically used as the basis for direct teaching activities, while the other six methods are more indirect ways of teaching. The 11 methods are:

1. Diagnostic prescriptive teaching
 2. Expository teaching
 3. Modeling
 4. Read/review/recite
 5. Competency-based education
 6. Simulations
 7. Projects
 8. Group process
 9. Inquire/discovery
 10. Facilitation
 11. Open experience
- (p. 108)

Fry, Medsker, and Bonner (1996) defined a variety of instructional methods and described their strengths. These methods can be useful in teaching. They noted that a combination of methods was probably best to achieve educational goals, rather than a single method. A variety of instructional methods and their strengths are presented in Table 3.

Table 3

Instructional Methods and Their Strengths

| Instructional Method | Definition | Strengths |
|--------------------------------|--|---|
| Lecture | Presentation of content by instructor | Can cover a lot of information quickly; instructor controls pace and structure |
| Discussion | Interchange of ideas and opinions by large or small groups of students | Gets students involved; increases interest; effective for controversial or open-end topics and creative problem solving |
| Application exercise | Individual students or small groups practice applying the course content to real or hypothetical situations | Essential to develop competence on key course objectives; actively involves students; helps transfer learning to the real world |
| Reading or workbook assignment | "Homework" done individually or in study groups; based on print materials designed for self-study | Can cover content as efficiently as lecture; saves class time for other activities that require interaction or discussion; self-paced and can be reviewed as needed |
| Test or quiz | Questions that determine how well students are learning course material; can be short or long, graded by teacher or self-assessed | Provides feedback to students and instructor regarding student progress; change of pace for use of class time; can motivate students to do assigned reading |
| Case study | Actual or hypothetical situation that illustrates course content; can be open-ended or include a conclusion | Demonstrate real-world application of course content; provides exciting basis for discussion, exercise, papers |
| Role play | Students assume roles of individuals or groups and act out planned or free-form scenarios; amount of structure varies depending on purpose | Effective in teaching attitudes and interpersonal skills; provides practice on course objectives; enhances transfer of learning to real world |
| Demonstration | Instructor or student shows how to do something; can be live or on videotape; hands-on physical activity explicated | Provides students with a model of how to perform; adds interest; if student-led, preparation is excellent learning experience |

(table continues)

| Instructional Method | Definition | Strengths |
|----------------------|---|---|
| Laboratory exercise | Students perform hands-on activity using real equipment, as in computer lab, kitchen, or video studio | Essential for learning to use specialized equipment; can get immediate, firsthand results; highly motivating and rewarding |
| Project | Individual or group activity done primarily out of class that applies or extends course content; results in a paper or concrete product | Provides practice on key course objectives; allows students to choose areas of most interest and apply to work setting; provides basis for substantive class discussion |
| Game | Simple to complex structure with rules; can be board game, "quiz show," or simulated "real life" | Fun, creative way to introduce or review course content; effective for teaching attitudes; can involve competition and/or cooperation, which is motivating |

Note. From "Teaching Methods and Strategies" by J. Fry, K. Medsker and D. Bonner, 1996. In V. Bianco-Mathis and N. Chalofsky (Eds.), The Adjunct Teachers Handbook (pp. 59-60). Thousand Oaks, CA: SAGE Publications, Inc.

Classroom Management

In ITV Classroom management, the researcher reviewed and concentrated on time management, behavior management, and instruction management.

Time Management

Hewit and Whittier (1997) stated that "the purpose of developing effective time management practices is not to complete everything, but rather to accomplish professional and personal goals" (p. 219). To effectively manage time,

they noted that teachers should establish clear goals and develop plans carefully, identify and eliminate time-wasters, make detailed classroom schedules, begin and end classes on time.

Behavior Management

Behavior management involves teacher and student responsibly managing themselves. For managing the ITV classroom, Lochte (1993) noted that there were checklists for ITV teachers and students. The checklist for ITV teachers included:

1. Dress properly for television.
2. Before you begin, make sure everything is working.
3. Start the VCRs to record the lesson.
4. Speak up and tell your students to do the same.
5. Wait before you respond to students at distance sites.
6. Ask questions of specific students every 10 minutes.
7. Use a seating chart at each site.
8. Pay attention to what the distant sites are seeing.
9. Write legibly and use thick markers.
10. When transmission fails, establish your backup communication link immediately; then try to get the ITV system working again. (p. 50)

Lochte also stated that checklist for ITV students included:

1. Make sure you sit in your assigned seat.
2. Identify yourself by name and class site when you want to speak or ask a question, then wait for your teacher to recognize you.
3. Pause and count to two before you speak.

4. Speak up and talk into the microphone.
5. Don't talk or make noise in class.
6. Clear away any books or papers you don't need from the desktop.
7. Any time you cannot hear or see anything for any reason, let your teacher know immediately. (p. 55)

Arends, Winitzky, and Tannenbaum (1998) stated that teacher enthusiasm had a positive impact on student learning. Collins (1978) stated that teacher enthusiasm was evidenced by: (a) varied vocal delivery, lilting, uplifting intonations and many changes in tone and pitch; (b) eyes were shining, frequently opened wide, eyebrows were raised and eye contact was frequently made with all students; (c) gestures were displayed through frequent movements of body, head, arms, hands, and face; sweeping motions; clapping hands; and rapid nodding of the head; (d) facial expression changes denoted surprise, sadness, joy, awe, thoughtfulness, and excitement; (e) word selection was highly descriptive using many adjectives with great variety; (f) students' ideas and feelings were quickly accepted with vigor and animation; (g) praise and encouragement were frequently used in response to students; (h) high degree of spirit was evident throughout the lesson.

Arends et al. (1998) reported that effective teachers' behavior included the effective use of time, active teaching, clarity of presentations, appropriate use of praise, having clear procedures, communicating higher performance expectations to students, having clear work requirements, monitoring student work carefully, and providing students with immediate feedback.

Moore (1998) stated that effective teacher behaviors involved providing students verbal and nonverbal reinforcements after their action or response. The verbal reinforcements are some types of positive comment, such as "good," "excellent," "correct," "that's right," and "well-done," etc. The nonverbal reinforcements involve applause, smiling, and thumb raising, etc.

Instructional Management

Kameenui and Darch (1995) stated that effective instructional classroom management took place before, during, and after phases of instruction. Before instruction, teachers should design detailed management plans. During instruction, teachers should manage their delivery. After instruction, teachers should evaluate their classroom performance.

Moore (1998) noted that "the key to effective teaching is planning" (p. 11). He pointed out that there were seven steps involved in the planning process (see Figure 3): identifying the content, writing objectives, introducing the lesson, selecting instructional strategy, closing the lesson, evaluating the lesson, and identifying new content to be taught.

To effectively manage an ITV classroom, Hobbs and Christianson (1997) stated that it was a good idea for teachers to prepare a detailed course syllabus. The course syllabus includes the ITV course title; academic year in which it is taught; the home school; credit hours; meeting date, time, and location; course instructor's name, office hours, office telephone number, home telephone number, mailing address, office Fax number, and e-mail address; course description; course prerequisites; course outline, units, topics, and objectives; textbook and/or other materials required; home work; assignments; and grading; etc. (Cyrs & Conway, 1997; Hobbs & Christianson, 1997).

Cangelosi (1997) said for effective classroom management the teacher should practice teaching in cycles, finishing many different teaching units. They should also

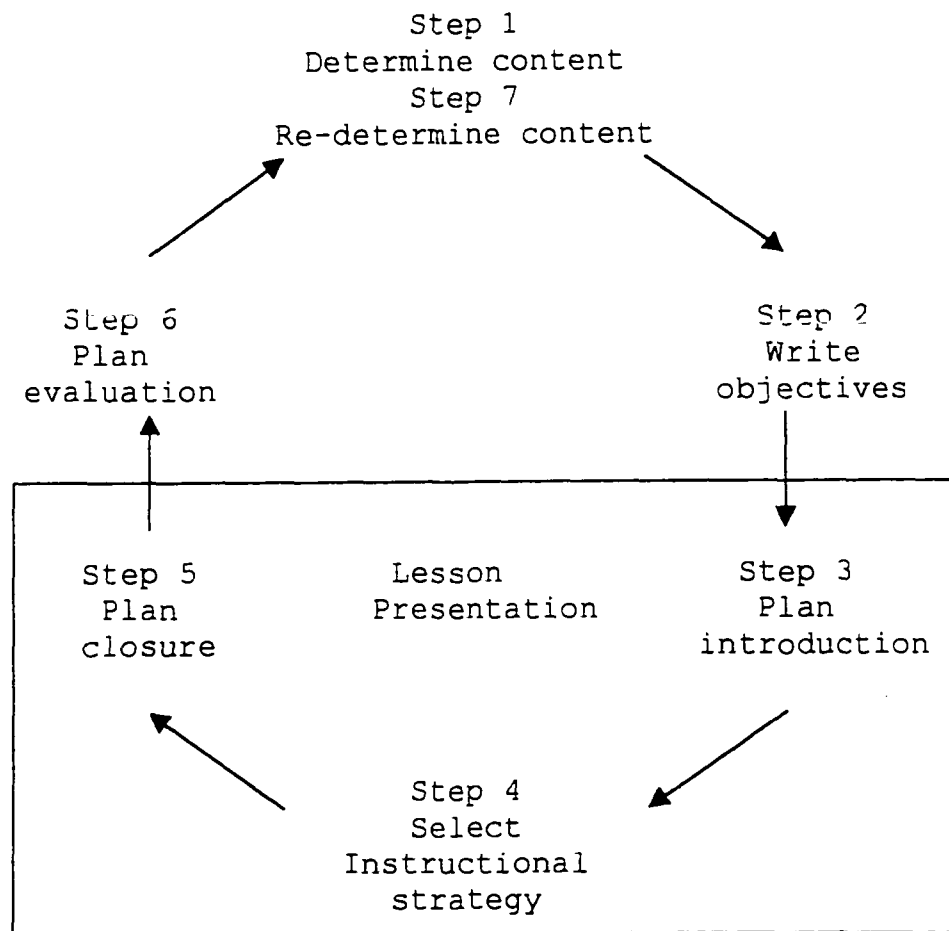

Figure 3. Basic Seven-Step Planning Process

Note. From Classroom Teaching Skills (4th ed., p. 12) by K. D. Moore, 1998, Boston: McGraw-Hill Companies, Inc.

design and conduct teaching units by affecting the six stages as Teaching Process Model (see Figure 4):

1. Determine needs of students.
2. Determine learning goals.
3. Design learning activities.
4. Prepare for the learning activities.
5. Conduct the learning activities.
6. Determine how well students have achieved the learning goal. (p. 5)

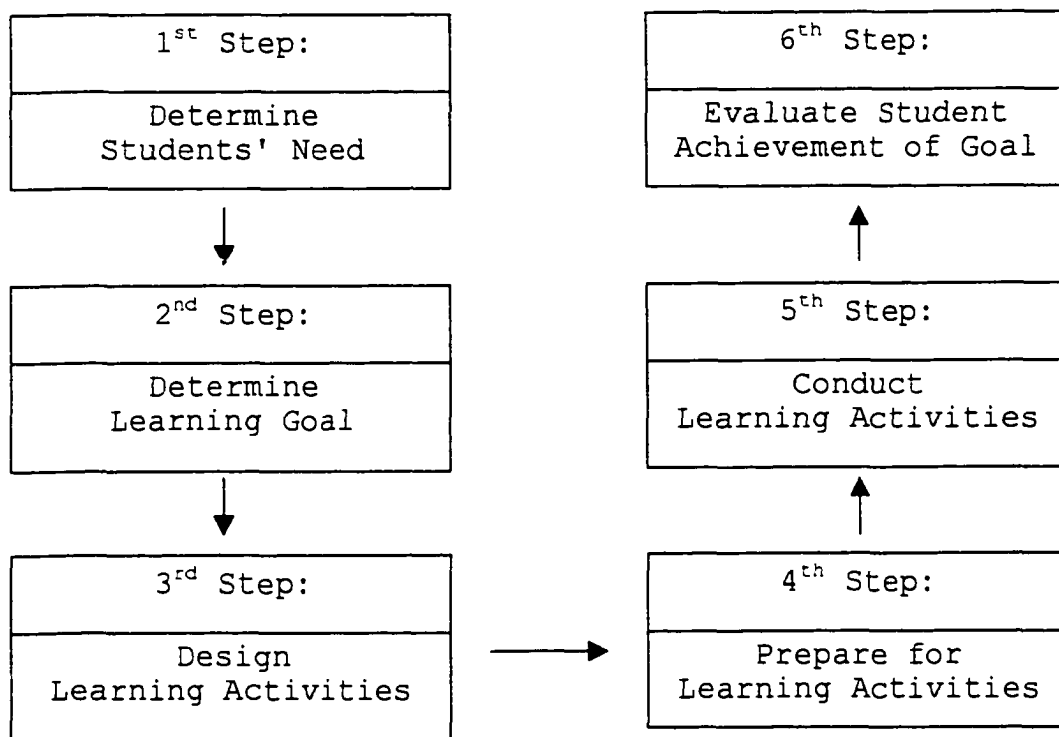

Figure 4. The Teaching Process Model

Note. From Classroom Management Strategies: Gaining and Maintaining Students' Cooperation (p. 6), by J. S. Cangelosi, 1997, New York: Longman.

Hewit and Whittier (1997) stated that a unit plan should include the title, instruction method, rationale, motivation, diagram of content areas, objectives, materials and resources (e.g., films, slides, prints, magazines, newspapers, pictures, videotapes, CD-ROM, music, computer programs, teacher-made materials, Internet and WWW resources, etc.), bibliography, and the lesson plan. A

lesson plan should include the topic, objective statements, materials required, procedures (e.g., set, delivery methods, examples, review, closure, bridge to the next lesson, evaluation, etc.), and guided practices.

Kameenui and Darch (1995) stated that reflecting on completed instruction was the final phase of instructional classroom management. After instruction, teachers should spend time evaluating and improving the lesson for the next session.

Improving Teaching

Cyrs and Conway (1997) state that when students participated in an interactive television class, they usually thought, "What's in it for me?" "Why do I need to learn?" "Can I use it?" In order to make teaching effective, before beginning of class the teacher should answer these questions. They suggest ways to motivate student learning in the teleclass: (a) tell students what they will learn, why they should learn, and how they can use the skill and knowledge; (b) give students handouts (e.g., syllabus, study guides, note) to help students to see the connections and relationships among ideas; (c) ask questions regarding important learning points that will be answered in the class; (d) get students actively involved

in their learning; (e) create curiosity; (f) create a dramatic situation; (g) cite an unusual statistic as a surprise; (h) use a magical illusion; (i) use humor to create laughter; and (j) give an analogy to the important learning point.

To improve teaching and learning, Cyrs and Conway (1997) and Hardman (1999) suggested teachers should design an Interactive Study Guide (ISG). The ISG is composed of a series of displays (see Figure 5 and Figure 6) which are mostly designed in word pictures (see Figure 7). The simplest way to create word pictures is to sketch them by hand in black and white. Colored markers can be used to differentiate key ideas.

The ISG is a highly organized set of geometric shapes, charts, graphics, pictures, activities, problems, notes, and exercises planned before a teleclass to help students with their note-taking and ease in understanding the material. It is also a management tool for teaching and learning that can be used before, during, and after teleclass (Cyrs & Conway, 1997).

| Display | Notes |
|--|-------|
|  <p>1</p> | |
|  <p>2</p> | |
| <p><u>Activity</u></p> <hr/> <hr/> <hr/> <p>3</p> | |

Figure 5. An Example of ISG (For students)

Note. Reference from Teaching at a Distance with the Merging Technologies: An Instructional Systems Approach (p. 109) by T. E. Cyrus and E. D. Conway, 1997, Las Cruces: New Mexico State University, Center for Education Development.

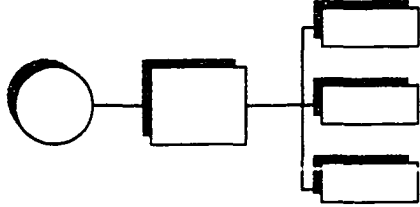
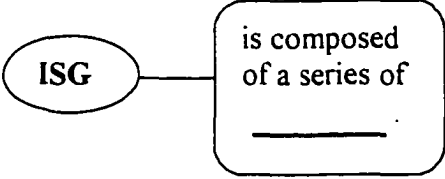
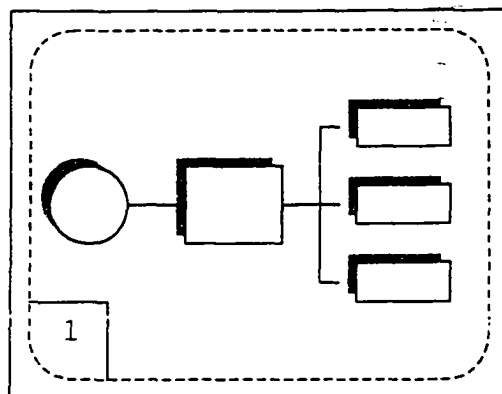

Figure 6. ISG Display on TV Screen

Note. Reference from Teaching at a Distance with the Merging Technologies: An Instructional Systems Approach (p. 109) by T. E. Cyr and E. D. Conway, 1997, Las Cruces: New Mexico State University, Center for Education Development.

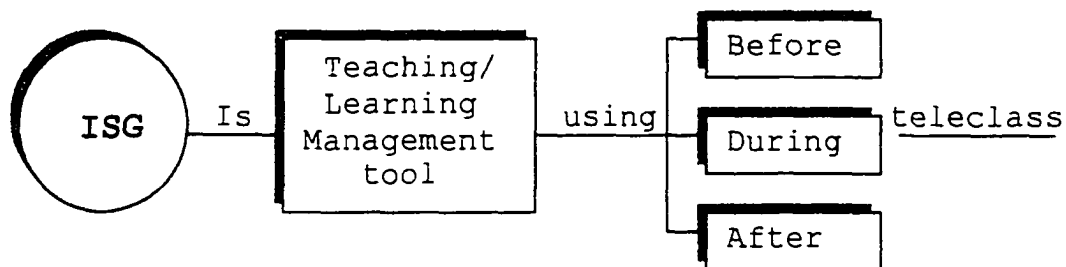

Figure 7. An Example of a Word Picture

Note. Reference from Teaching at a Distance with the Merging Technologies: An Instructional Systems Approach (p. 104) by T. E. Cyr and E. D. Conway, 1997, Las Cruces: New Mexico State University Center for Education Development.

Interactive Teaching

Wagner (1997) stated that interactions enabled learner participation in the instructional process, enabled clarification and transfer of new ideas to already held concept frameworks, and could promote motivation of learning. Therefore, when building interaction into learning, teachers should consider the following functions of interaction: to increase participation, build a team, develop communication, obtain feedback, discover new constructs, support learner control or self-regulation, increase motivation, enhance elaboration and retention, negotiate understanding; also for exploration, clarification of understanding, and closure.

In 1989, Moore offered three types of instructional interaction: That which occurred between the learner and the instructor; that which occurred among learners; and, those that took place between learners and the content they were trying to master (Wagner, 1997).

Interactive Television

In this section, the researcher reviewed the evolution of interactive television, ITV classroom equipment, and ITV attributes.

Evolution of Interactive Television

During the 1950s the cable television industry employed interactivity via telephone lines to encourage viewer response. Now TV talk shows can allow viewers to call in and participate in the program (Lochte, 1993). These are examples of one-way video and two-way audio communication system.

In 1964 at the New York World's Fair, AT&T introduced the Picture Phone, which allowed telephone users to talk, see, and hear each other virtually face-to-face. The business community took advantage of holding face-to-face meetings utilizing two-way television for saving travel expenses. As costs came down during the 1970s, teleconferences and videoconferences, examples of two-way audio and video communication, became more common (Lochte, 1993). A cluster of schools in Minnesota used two-way interactive television systems in the 1980s to transmit two-way video and audio signals from origination site to one or more remote sites. This technology made full interactivity possible (Hobbs & Christianson, 1997).

In the 1990s computers were added to the interactive television system to store information which then could be used at a more convenient time, and to transfer data and

text between the parties. Conventional coaxial cable, microwave links, fiber optics, communication satellites, and Instructional Television Fixed Services (ITFS) made transmission possible. Computer-based interactive television created an environment of real-time, full-motion video, and virtual realities (Hobbs & Christianson, 1997; Lochte, 1993; Office of Technology Assessment, 1989). UNI and NKNU ITV programs use such contemporary interactive television systems.

ITV Classroom Equipment

The ITV classroom utilizes the following equipment: teacher camera, student camera, overhead camera (or document camera), special camera, student microphones, teacher microphones, speakers, television monitors, touch-screen control, computer, telephone, facsimile machine, Video cassette recorder (VCR), laser-disk player, CD-ROM player, audio tape player, slide units, satellite up-link and down-link equipment, Internet connection, screen projector, and other form of media (Hobbs & Christianson, 1997; Lochte, 1993).

The overhead camera (or document camera) is a particularly valuable instructional tool since it can be used to project written materials. Since the overhead

camera can reduce or enlarge images, it can be used to display documents of various print sizes, as well as diagrams, photographs, or any other kinds of visual images. It can also be used to display three-dimensional objects in outstanding detail and clarity at both origination and remote sites. This versatility of the overhead camera makes it a favorite among ITV teachers (Hobbs & Christianson, 1997).

ITV Attributes

Two-way ITV can encourage district schools to offer low-enrollment and special advanced courses to their students. Each ITV classroom can send and receive continuous full-motion video and audio signals; the teacher and remote students can simultaneously and immediately see and hear each other at all times. In addition, the ITV system can be used for conferences, business and agency seminars, school administrators' meetings, teacher in-service workshops, job training, and adult education, etc. (Hobbs & Christianson, 1997).

Survey

Alreck and Settle (1995) pointed out, "Even when the information is available through other means, survey research may be an easier, quicker, less expensive, or more

accurate way to get the required information" (p. 3). In this section, the researcher reviewed the questionnaire and interview, Likert scales, and validity of the instrument.

Questionnaire and Interview

Hittleman and Simon (1997) noted that surveys included questionnaires and interviews. Questionnaires require the respondents to write answers to the questions. Interviews are used to ask respondents open-ended questions and to record the oral answers.

Alreck and Settle (1995) stated, "When the survey is self-administered, such as mail surveys are, the instrument is called a questionnaire" (p. 143). There are many advantages to using a questionnaire survey. Babbie (1990) stated that "self-mailing questionnaires have many advantages in terms of ease, economy, and response rate" (p. 178). Ary, Jacobs, and Razavieh (1990) indicated, "It is possible to include a large number of subjects as well as subjects in more-diverse locations than is practical with the interview. Another advantage is that a questionnaire that can guarantee confidentiality may elicit more truthful responses than would be obtained with a personal interview" (p. 421). Alreck and Settle (1995) pointed out, "The self-administered questionnaire is an

excellent way to interrogate respondents and obtain information" (p. 208). Therefore, a questionnaire survey of data collection was used for this study.

Gall, Borg, and Gall (1996) indicated that mailed questionnaire could be a very valuable research tool in education. The major steps of conducting a questionnaire survey include: (a) defining objectives, (b) selecting a sample, (c) writing items, (d) constructing the questionnaire, (e) pre-tests, (f) preparing a letter of transmittal, (g) sending out questionnaire, and (h) follow-ups. Wiersma (1995) suggested the steps in conducting a survey in Figure 8. The left side indicates the major steps, and the right shows the activities that come under each step.

Babbie (1990) stated that a follow-up mailing was an effective method for increasing return rates in mail surveys. He noted that "within two weeks after the first mailing, approximately 40 percent of the questionnaires would be returned; within two weeks after the first follow-up, an additional 20 percent would be received, and within two weeks after the final follow-up, an additional 10 percent would be received" (p. 181). He felt, "A response rate of at least 50 percent is generally considered

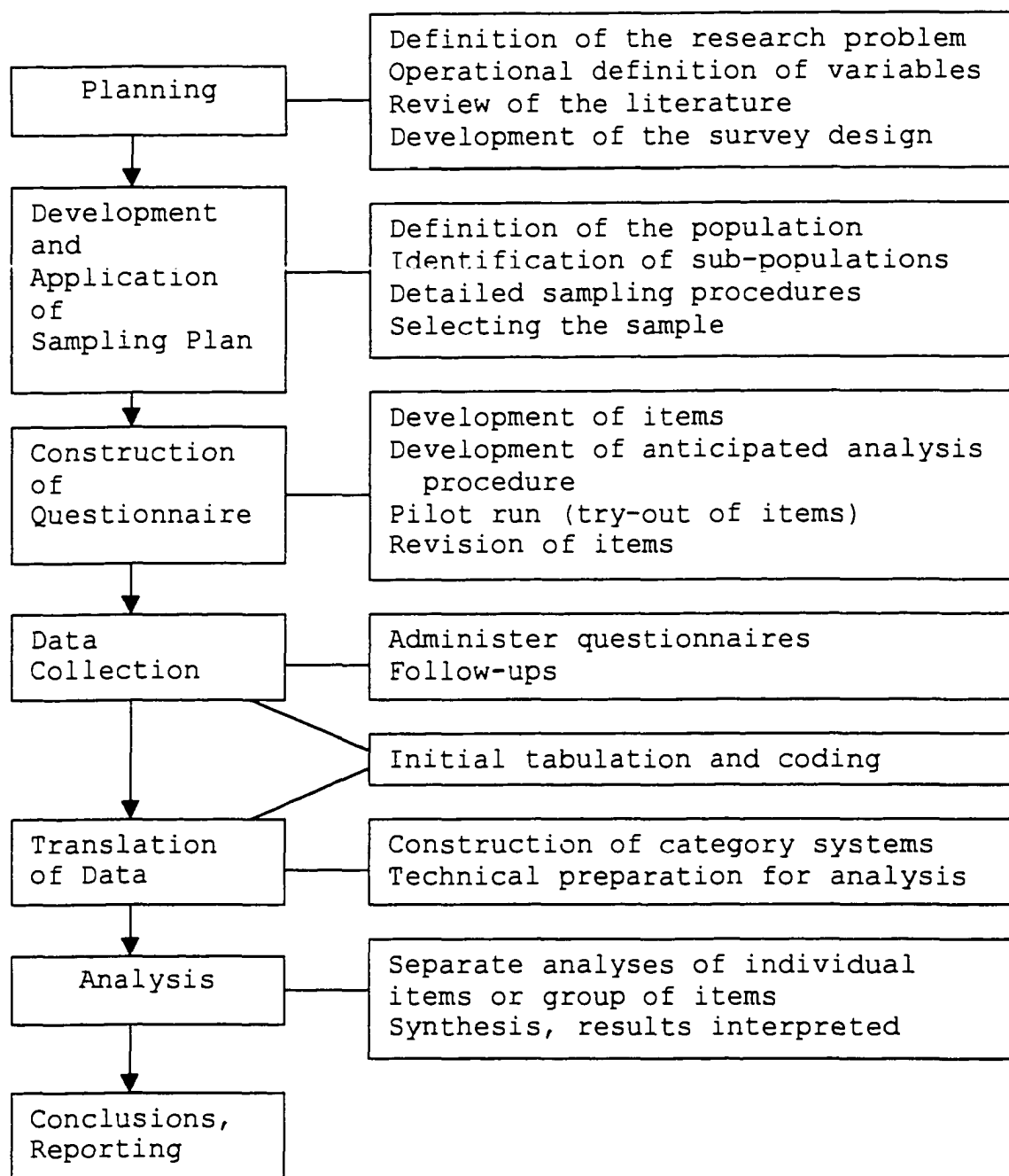

Figure 8. Flowchart in Conducting a Questionnaire Survey
 Note. From Research Methods Education: An Introduction (6th ed., p. 178) by W. Wiersma, 1995, Needham Heights, MA: A Simon and Schuster Company.

adequate for analysis and reporting. A response rate of at least 60 percent is considered good; and, a response rate of 70 percent or more is very good" (p. 182). Behling (1976) noted that from doing a survey "you can normally expect a 30 percent return" (p. 56). Babbie (1990) noted that there was no statistical basis concerning the response rate. Gall et al. (1996) stated that "in correlation research it is generally desirable to have a minimum of 30 cases" regarding sample size (p. 233). Charles (1998) noted that "samples used in correlation research should be no smaller than 30" (p. 147). Therefore, the returned questionnaires should be at least 30 cases for each group.

Alreck and Settle (1995) pointed out that the first section of the questionnaire was to introduce the survey to the respondents. The internal sections should contain the items and scales to measure the survey topics in a logical sequences. The final section should have questions to measure the respondents' characteristics; therefore, they can be grouped and compared.

In order to ensure a good return rate of survey, the following suggestions by Ary et al. (1990) and Babbie (1990) should be kept in mind when developing a

questionnaire. Their suggestions for a mailed questionnaire were:

1. The items should be clear and unambiguous.
2. Avoid double-barreled questions.
3. Avoid negative items.
4. Avoid biased terms and items.
5. Keep the questionnaire short, simple and brief.

Likert Scale

A Likert scale (see Figure 9) is a five-point scale in which the interval between each point on the scale is assumed to be equal. Tuckman (1988) stated that "this scale was used to register the extent of agreement or disagreement with a particular statement of an attitude, belief, or judgement" (p. 192).

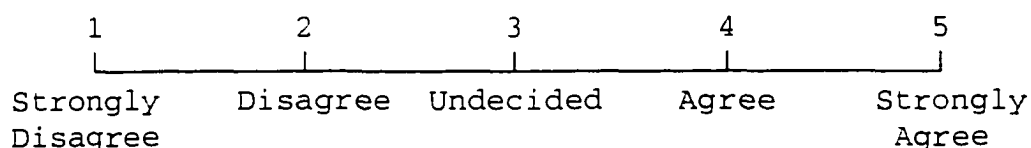

Figure 9. Likert Scale

Validity of the Instrument

Validity is an attempt to determine whether the questionnaire is really measuring what it is supposed to

measure (Ary et al., 1990). Ary et al. (1990) indicated that "the most obvious type of validity evidence needed is content-related" (p. 434). Litwin (1995) pointed out that "content validity is a subjective measure of how appropriate the items seem to a set of reviewers who have some knowledge of the subject matter" (p. 35). Litwin also noted, "Content validity is not quantified with statistics. Rather, it is presented as an overall opinion of a group of trained judges" (p. 35).

Summary

The basic characteristic of distance education is that both teacher and students are physically separated by location. This method of education includes two approaches to time: asynchronous and synchronous. Correspondence study is an example of asynchronous learning and ITV distance education is an example of synchronous learning.

The teacher is the key to success in distance learning. If the teacher is not good, then no amount of technology can overcome poor teaching. Teaching is a critical issue in distance education. Before teaching ITV courses, teachers should be trained to know the skills of using various technologies, and to know the principals of designing a lesson plan.

ITV distance learning has created an environment of real-time, full-motion video, and virtual reality. ITV distance learning can reach the goal of distance education and offer remote students an educational experience that is as similar to that of traditional, face-to-face instruction as possible. In addition, the ITV system can be additionally used for conferences, meetings, workshops, and training, etc.

CHAPTER III

METHODOLOGY

The methodology of this study included: (a) identification of the accessible population, (b) sampling methods, (c) preparation of the survey instrument, (d) validity of the instrument, (e) collection of the data, and (f) analysis of the data.

Identification of the Accessible Population

The accessible population of this study consisted of four groups. Group one was the teachers who had teaching experiences in the UNI ITV program. There were 64 teachers who have taught the ITV courses in this program. Group two consisted of the students who had learning experiences in the UNI ITV program. In the fall semester 1999, 413 students were enrolled in the ITV courses. Group three was the teachers who had teaching experiences in the NKNU ITV program. In this program, 53 teachers have taught the ITV courses. Group four was the students who had learning experiences in the NKNU ITV program. In the fall semester 1999, 717 students were enrolled in ITV courses (see Figure 10).

| | | <u>School</u> | |
|---------------|----------|---------------|------|
| | | UNI | NKNU |
| <u>Member</u> | Teachers | 64 | 53 |
| | Students | 413 | 717 |

Figure 10. The Population of Four Groups

Sampling Methods

Ary et al. (1990) stated, "The best known of the probability sampling procedures is simple random sampling. The basic characteristic of simple random sampling is that all members of the population have an equal and independent chance of being included in the sample" (p. 172). In this study, the researcher used the simple random sampling.

The research involved human subjects; therefore, the researcher applied for and received permission to use the name list of population group one and group two from the Human Subjects Review Board of the Graduate College of UNI (see Appendix C). Also, the researcher applied for and received the name list of group three and group four population from NKNU ITV program register offices. Group one sampled 40, group two sampled 300, group three sampled

40, and group four sampled 300 to answer the questionnaires (see Figure 11).

| | | <u>School</u> | |
|---------------|----------|---------------|------|
| | | UNI | NKNU |
| <u>Member</u> | Teachers | 40 | 40 |
| | Students | 300 | 300 |

Figure 11. The Samples of Four Groups

Preparation of the Survey Instrument

Preparation of the survey instrument included development of the questionnaires and structure of the questionnaires.

Development of the Questionnaires

To support the research purposes and to identify the research questions, two questionnaires were developed according to the Ary et al. (1990) and Babbie (1990) suggestions and a Likert scale was used to register the extent of agreement or disagreement.

Structure of the Questionnaires

Two kinds of questionnaires were distributed for this study: One was for teachers; the other was for students. The contents of the questionnaire were adapted from several research projects or publications: Chute, Thompson, and Hancock, (1999); Conti (1998); Gold (1997); Goro (1995); Herring and Smaldino (1998); Hilgenberg (1997); Hobbs and Christianson (1997); Nelson (1997); Newble and Cannon (1991); Parks (1997); Rueschman (1998); Silvernail and Johnson (1992); and Webster and Hackley (1997).

The Teacher Questionnaire was divided into one demographic question (Questionnaire 01) and followed by four parts. Part I included 17 questions (i.e., Q02-Q18) investigated ITV teaching methods. Part II included seven questions (i.e., Q19-Q25) and investigated ITV classroom management. Part III included seven questions (i.e., Q26-Q32) and investigated respondents' attitudes toward ITV classes. Part IV included seven questions (i.e., Teacher Questionnaire 33-39) and investigated the demographic information of respondents.

The Student Questionnaire was also divided into one demographic question and followed by four parts. Part I, II, and III were the same as the Teacher Questionnaire.

Part IV included four questions (i.e., Student Questionnaire 33-36) and investigated the demographic information of the respondents.

Validity of the Instrument

In this study, a panel of four experts (see Appendix A) who had experiences in ITV class were asked to review the questionnaires and make suggestions for revision.

After the questionnaires were developed, the first drafts were submitted to the dissertation advisory committees for their input and recommendation. Then, a pilot-test was conducted on five teachers and five students. From the feedback of the pilot-test, consulting with the experts, the researcher found that there were no structural problems. But some modifications were made in the wording in order that the respondents could more easily read and understand the survey. Clarification of one question's meaning, elimination of one question, and arrangement of question numbers were also made according to the suggestions. Then, the revised questionnaires were translated into Chinese by the researcher, because the respondents in Taiwan could read Chinese better than English.

To avoid ambiguity and misunderstanding resulting from language translation, the translated questionnaires were verified by Dr. Taifa Yu and Dr. Pen-shui Liao. Dr. Yu is a professor at UNI on the dissertation committee and is proficient in both English and Chinese. Dr. Liao is a professional expert of English and Chinese translation, and he is a professor and chairman of the Department of English of NKNU.

Collection of Data

A self-administered questionnaire mail survey was used for this study to collect data. After the questionnaires were revised, approved, and translated in Chinese, the printed English and Chinese versions of questionnaire were sent by mail to the sample subjects. The mailing for the samples of UNI ITV program teachers/students included a cover letter (see Appendix D), a teacher/student questionnaire (see Appendix E and Appendix F), a self-addressed stamped envelope, and a note (see Appendix G). The note asked the sample subjects if they would like to receive a summary of the results of this study. The mailing for the samples of NKNU ITV program teachers/students included a cover letter in Chinese (see Appendix H), a teacher/student questionnaire in Chinese (see

Appendix I and Appendix J), a self-addressed stamped envelope, and a note in Chinese (see Appendix K). The cover letter focused on the following points: (a) protection for the respondent, (b) request for cooperation, (c) the purpose of the research, (d) the deadline for return, (e) a statement on the confidentiality of individual responses, (f) identification of the researcher's name and position, and (g) a thanks for help. In order to get a good return rate the researcher used this follow-up method. A few weeks after the first questionnaire was sent out, the researcher solicited the cooperation of those who had not yet returned their questionnaires by sending them a follow-up mailing. The follow-up mailing included a cover letter, questionnaire, stamped, return-addressed envelope, and a note. Four steps were followed in the data collection process:

1. Coded each return-addressed envelope according to the name list samples.
2. Prepared and sent first mailings.
3. Sent follow-up mailing.
4. Completed the survey.

The first wave of mailings was sent to the samples of UNI teachers and students on February 21, 2000. The second

wave of mailings was sent to the samples of the teachers and students of the NKNU ITV program on March 6, 2000. The follow-up mailings to the non-respondents of teachers and students of NKNU ITV program were sent on March 27, 2000. The follow-up mailings were sent to the non-respondents of UNI teachers and students on April 17, 2000. After four waves of mailing, the survey was completed on May 1, 2000. The researcher received 33 questionnaires from the UNI teachers group, 161 from the UNI student group, 30 from the NKNU teachers group, and 183 from the NKNU student group. The return rates were 82.5% for the UNI teachers group, 53.7% for the UNI student group, 75% for the NKNU teachers group, and 61% for the NKNU student group.

Babbie (1990) said that as a general rule 50% or more response rate was sufficient for valid data analysis and reporting. Since the response rate for each of the four groups of this study exceeded 50% the return rate was considered acceptable for the study.

Analysis of the Data

After the survey was completed and returned the questionnaires were arranged and organized, the information was collected and the researcher used a computer program to process the data. The SPSS program was used to conduct the

statistical analysis. Descriptive and inferential statistical methods were used to analyze the data.

The frequency distributions and percentage methods were used to analyze the demographic information of the four groups. These methods were to answer the Research Question 4.

The mean, standard deviation, Chi-Square statistics, and a two-way ANOVA at level .05 were used for each item of ITV teaching method variables, ITV classroom management variables, and for ITV class attitude variables to analyze and identify any significant differences between UNI and NKNU ITV programs. For the purpose of explanation, the researcher defined that the mean scores from 2.50 to 2.99 were weakly disagree, from 3.00 to 3.49 were weakly agree, from 3.50 to 3.99 were moderately agree, from 4.00 to 4.49 were highly agree, and from 4.50 to 5.00 were strongly agree. To compare the percentages of answering "Not Used," the researcher used Chi-Squire statistics. These methods were to answer the Research Question 1, 2, and 3.

CHAPTER IV

DATA PRESENTATION AND FINDINGS

This chapter presents the data and findings of this research. All of the findings were derived from an analysis of the collected data to answer the research questions. The following five sections are included in the report in order to facilitate the presentation of the data and findings:

1. Description of responses.
2. Research Question 1.
3. Research Question 2.
4. Research Question 3.
5. Research Question 4.

Description of Responses

The first mailing was composed of 340 questionnaires and sent to 40 teachers and 300 students, all participants in the UNI ITV program. The second mailing consisted of 340 questionnaires and was sent to 40 teachers and 300 students, all participants in the NKNU ITV program. Three hundred and one subjects returned their responses before March 21, 2000 for a return rate of 44.3%. A follow-up mailing was then sent to the subjects who had not yet responded: 106 of these subjects answered. The return rate

for this follow-up was 27.9%. As a result, 407 questionnaires were returned, including 33 UNI teachers, 161 UNI students, 30 NKNU ITV program teachers, and 183 NKNU ITV program students.

The return rates were 82.5% for UNI teachers, 53.7% for UNI students, 75% for the teachers in the NKNU ITV program, and 61% for the students in the NKNU ITV program. However, 10 of the returned questionnaires were unusable for data analysis because of missing values on many questions. The distribution of the respondents is illustrated in Table 4.

The response data for each questionnaire item was organized into a two-way classification figure as shown below:

| | | <u>School</u> | |
|---------------|----------|---------------|------|
| | | UNI | NKNU |
| <u>Member</u> | Teachers | | |
| | Students | | |

Table 4

Questionnaire Mailing and Response

| Items | UNI Teachers | UNI Students | NKNU Teachers | NKNU Students | Total |
|-------------------------|-----------------|-----------------|------------------|------------------|-------|
| First mailing (2/21) | 40 | 300 | | | 340 |
| Responses (2/21 - 3/10) | 29 | 116 | | | 145 |
| Second mailing (3/6) | | | 40 | 300 | 340 |
| Responses (3/6 - 3/21) | | | 23 | 133 | 156 |
| Follow-up (3/27) | | | 17 | 167 | 185 |
| Responses (3/27 - 4/11) | | | 7 | 50 | 57 |
| Follow-up (4/17) | 11 | 184 | | | 195 |
| Responses (4/17 - 5/1) | 4 | 45 | | | 49 |
| Total responses | 33 | 161 | 30 | 183 | 407 |
| Response rates | 82.5% | 53.7% | 75% | 61% | 59.9% |
| Unusable responses | 1 | 4 | 0 | 5 | 10 |
| Usable responses | 32 | 157 | 30 | 178 | 397 |
| Usable rate | 80% | 52.3% | 75% | 59.3% | 58.4% |

Note. The numbers inside the parentheses indicate the dates of mailing and the duration of time allowed for receiving responses. The survey was completed on May 1, 2000.

Each of the following research questions was addressed using the data organized in that classification figure.

Research Question 1

Research Question 1: What are the similarities and/or differences in the teaching methods used in the UNI and NKNU ITV programs?

Part I of the questionnaire was designed to gather data regarding ITV teaching methods. There were 17 items in this part (see Appendix E and Appendix F).

For each of the questionnaire items, the frequency, percentage, mean, and standard deviation are presented in Appendix L. The data for the four groups can be conceived as being organized in the two-way classification table as shown above. The resulting two-way ANOVA summary tables and Chi-Square values are also shown in Appendix L. It was unnecessary to compare the items of respondents who answered "Not Used" which were under 5% in both schools. Therefore, the researcher didn't calculate those items.

The data were arranged into three kinds of tables to examine the similarities and differences. Table 5 was first: Comparison of Percentage of Two School Respondents Answering "Not Used." Second, Table 6: School Factor Data for Those Questionnaire Items Showing No Statistical

Significant Differences at the .05 Level. Third, Table 7:
School Factor Data for Those Questionnaire Items Showing
Statistical Significant Differences at the .05 Level.

Table 5

Comparison of Percentages of Two School Respondents
Answering "Not Used"

| Questionnaire Items | UNI | | | NKNU | | | χ^2 Value |
|------------------------|----------|----------|-------|----------|----------|-------|-------------------|
| | <u>n</u> | <u>f</u> | % | <u>n</u> | <u>f</u> | % | |
| ITV Teaching Methods | | | | | | | |
| 02 | 189 | 1 | 0.5% | 208 | 0 | 0.0% | # |
| 03 | 189 | 5 | 2.6% | 208 | 19 | 9.0% | 7.34* |
| 04 | 187 | 1 | 0.5% | 206 | 6 | 3.4% | # |
| 05 | 189 | 0 | 0.0% | 207 | 7 | 3.4% | # |
| 06 | 189 | 3 | 1.6% | 207 | 8 | 3.9% | # |
| 07 | 188 | 69 | 36.7% | 208 | 38 | 18.3% | 17.01* |
| 08 | 189 | 35 | 18.5% | 208 | 40 | 19.2% | 0.03 |
| 09 | 188 | 25 | 13.8% | 208 | 11 | 5.3% | 7.66* |
| 10 | 189 | 19 | 10.1% | 208 | 24 | 11.5% | 0.23 |
| 11 | 189 | 5 | 2.6% | 208 | 30 | 14.4% | 17.09* |
| 12 | 189 | 3 | 1.6% | 208 | 10 | 4.8% | # |
| 13 | 189 | 22 | 11.6% | 207 | 23 | 11.1% | 0.03 |
| 14 | 189 | 0 | 0.0% | 208 | 1 | 0.5% | # |
| 15 | 189 | 96 | 50.8% | 208 | 34 | 16.3% | 53.36* |
| 16 | 189 | 11 | 5.8% | 208 | 13 | 6.3% | 0.03 |
| 17 | 189 | 1 | 0.5% | 207 | 10 | 4.8% | # |
| 18 | 189 | 2 | 1.0% | 208 | 20 | 9.6% | 13.86* |

Note. Contents of questionnaire items (02~18) are presented
in Appendix E and Appendix F.

$$\chi^{2.95 (1)} = 3.84$$

It is unnecessary to compare the items which percentages
are under 5% in both schools.

Table 6

School Factor Data for Those Questionnaire Items Showing No Statistical Significant Differences at the .05 Level

| Questionnaire Items | UNI | | | NKNU | | | <u>p</u> |
|----------------------------|----------|----------|-----------|----------|----------|-----------|----------|
| | <u>n</u> | <u>M</u> | <u>SD</u> | <u>n</u> | <u>M</u> | <u>SD</u> | |
| ITV Teaching Methods | | | | | | | |
| 02 | 188 | 4.27 | 0.88 | 208 | 4.30 | 0.62 | .43 |
| 03 | 184 | 3.72 | 1.12 | 189 | 3.81 | 0.95 | .36 |
| 05 | 189 | 3.92 | 0.87 | 200 | 3.84 | 0.79 | .87 |
| 06 | 186 | 4.06 | 0.94 | 199 | 3.93 | 0.87 | .67 |
| 07 | 119 | 3.40 | 1.30 | 170 | 3.38 | 1.13 | .33 |
| 08 | 154 | 4.02 | 1.13 | 168 | 3.49 | 1.08 | .12 |
| 09 | 163 | 3.72 | 1.10 | 197 | 3.58 | 0.97 | .67 |
| 12 | 186 | 3.92 | 0.93 | 198 | 3.84 | 0.83 | .57 |
| 13 | 167 | 3.77 | 0.94 | 184 | 3.58 | 0.87 | .42 |
| 14 | 189 | 4.10 | 0.89 | 207 | 4.14 | 0.73 | .37 |
| 15 | 93 | 3.32 | 1.08 | 174 | 3.37 | 0.97 | .06 |
| 16 | 178 | 3.58 | 0.93 | 195 | 3.24 | 0.99 | .17 |
| 17 | 188 | 3.90 | 0.99 | 197 | 3.53 | 0.96 | .18 |
| 18 | 187 | 3.53 | 1.10 | 188 | 3.49 | 0.99 | .66 |
| ITV Classroom Management | | | | | | | |
| 19 | 188 | 3.82 | 1.05 | 205 | 3.80 | 1.05 | .85 |
| 20 | 186 | 3.75 | 1.10 | 205 | 3.46 | 1.06 | .55 |
| 23 | 189 | 3.70 | 1.04 | 207 | 3.87 | 0.79 | .29 |
| Attitudes Toward ITV Class | | | | | | | |
| 26 | 189 | 4.02 | 1.05 | 208 | 4.11 | 0.72 | .06 |
| 27 | 189 | 4.03 | 1.00 | 208 | 4.05 | 0.72 | .06 |
| 28 | 189 | 4.09 | 0.97 | 207 | 3.89 | 0.92 | .18 |
| 29 | 189 | 3.94 | 1.04 | 208 | 3.76 | 0.89 | .75 |

Note. Contents of questionnaire items (02-29) are presented in Appendix E and Appendix F.

Table 7

School Factor Data for Those Questionnaire Items Showing
Statistical Significant Differences at the .05 Level

| Questionnaire Items | UNI | | | NKNU | | | ES | p |
|--------------------------|----------|----------|-----------|----------|----------|-----------|------|-----|
| | <u>n</u> | <u>M</u> | <u>SD</u> | <u>n</u> | <u>M</u> | <u>SD</u> | | |
| ITV Teaching Methods | | | | | | | | |
| 04 | 186 | 3.96 | 0.80 | 200 | 3.61 | 0.97 | 0.38 | .01 |
| 10 | 170 | 3.89 | 0.84 | 184 | 3.37 | 0.95 | 0.56 | .01 |
| 11 | 184 | 3.72 | 1.08 | 178 | 2.95 | 1.17 | 0.65 | .01 |
| ITV Classroom Management | | | | | | | | |
| 21 | 167 | 3.93 | 1.15 | 200 | 3.42 | 1.13 | 0.44 | .02 |
| 22 | 189 | 4.02 | 0.98 | 203 | 3.06 | 1.11 | .83 | .01 |
| 24 | 187 | 3.45 | 1.18 | 207 | 2.87 | 1.15 | 0.48 | .01 |
| 25 | 187 | 3.75 | 1.01 | 203 | 3.19 | 0.98 | 0.54 | .01 |

Note. ES was computed using the pooled Standard Deviation. Contents of questionnaire items (04, 10, 11, 21, 22, 24, 25) are presented in Appendix E and Appendix F

The data showing similarities and differences are presented in Chapter IV, but will be discussed in Chapter V.

Similarities

As seen in Table 5, Questionnaire Items 08 (i.e., Q08), Q10, Q13, and Q16, there was an approximately equal percent in both schools answering "Not Used" for their respective ITV programs. When subjected to Chi-Square analysis, each of these four items presented no significant statistical difference between the schools.

As was defined previously, the mean scores were defined as follows: weakly disagree (2.50-2.99), weakly agree (3.00-3.49), moderately agree (3.50-3.99), highly agree (4.00-4.49), and strong agree (4.50-5.00).

As seen in Table 6, both schools' respondents highly agreed to items Q02 and Q14; moderately agreed to items Q03, Q05, Q06, Q08, Q09, Q12, Q13, Q17, and Q18 and weakly agreed to items Q07, Q15, and Q16.

Differences

Table 5 items Q07, Q09, and Q15 indicated a larger percentage of UNI respondents answered "Not Used" than NKNU respondents. However, a larger percentage of NKNU than UNI respondents answered that way to items Q3, Q11, and Q18.

In Table 7, both UNI and NKNU were in the moderate agreement range on item Q04, although UNI was statistically, significantly higher than NKNU. UNI respondents moderately agreed, while NKNU respondents weakly agreed to item Q10. UNI respondents moderately agreed, while NKNU respondents weakly disagreed with item Q11.

Research Question 2

Research Question 2: What are the similarities and/or differences between classroom management practices in the UNI and NKNU ITV programs?

Part II of the questionnaire was designed to gather data regarding ITV classroom management. There were seven items in this part (see Appendix E and Appendix F). The frequency, percentage, mean, and standard deviation are presented in Appendix M. The resulting two-way ANOVA summary tables are also shown in Appendix M.

Similarities

As seen in Table 6, all respondents of UNI and NKNU moderately agreed to items Q19, Q20, and Q 23.

Differences

UNI respondents moderately agreed and NKNU respondents weakly agreed to item Q21 in Table 7. UNI respondents highly agreed, and NKNU respondents weakly agreed to item Q22. UNI respondents weakly agreed, and NKNU respondents weakly disagreed with item Q24. UNI respondents were in moderate agreement, and NKNU respondents were in weak agreement with item Q25.

Research Question 3

Research Question 3: What are the similarities and/or differences in teacher and student attitudes toward UNI and NKNU ITV programming?

Part III of the questionnaire was designed to gather data regarding participants' attitudes toward ITV classes. There were seven items (including three open-end items) in this part (see Appendix E and Appendix F). The frequency, percentage, mean, and standard deviation for these items are presented in Appendix N. The resulting two-way ANOVA summary tables are also shown in Appendix N.

Similarities

Table 6 indicates respondents from both UNI and NKNU highly agreed to items Q26, Q27, and moderately agreed to items Q28 and Q29.

Differences

There were no statistical significant differences between these two schools on the attitude items.

Open-end Questions

There were three open-end questions. First: What is one thing that you like best about ITV classes (Q30)?
Second: What is one thing that you dislike most about ITV

classes (Q31)? Third: Are there any comments about classes you would like to add (Q32)?

One Thing That You Like Best about ITV Classes
(see Appendix O)

Thirty-two UNI teacher respondents (100%), 145 UNI student respondents (92.4%), 27 NKNU teacher respondents (90%), and 124 NKNU student respondents (69.7%) responded to questionnaire item Q30. The responses from the UNI ITV teachers, UNI ITV students, NKNU ITV teachers, and NKNU ITV students were arranged and presented in this section.

UNI ITV teachers indicated as their modal response that convenience for students was one thing that they liked best about ITV classes. The modal response of UNI ITV students was that having not to travel long distance for class was one thing that they liked best. The modal response of NKNU ITV teachers was that discussion with many different university students at the same time was one thing that they like best. The modal response of NKNU ITV students was that interaction with another university students was one thing that they like best. The other responses are also presented in Appendix O.

One Thing That You Dislike Most about ITV Classes
(see Appendix P)

There were 32 UNI teacher respondents (100%), 141 UNI student respondents (89.8%), 26 NKNU teacher respondents (86.7%), and 120 NKNU student respondents (76.4%) who responded to the questionnaire item Q31.

The modal response of UNI ITV teachers was that system or technology breakdown was one thing that they disliked most. The modal response of UNI ITV students was that technology failure was one thing that they disliked most. The modal response of NKNU ITV teachers was that system breakdown was one thing that they disliked most. The modal response of NKNU ITV students was that system breakdown was one thing that they disliked most. The other responses are also presented in Appendix P.

Comments About ITV Classes
(see Appendix Q)

There were 15 UNI teacher respondents (46.9%), 80 UNI student respondents (51.0%), 18 NKNU teacher respondents (60.0%), and 42 NKNU student respondents (23.6%) who answered Q32 in the questionnaire.

One UNI ITV teacher commented: "I wish the technology would allow the instructor to hear all sites at once as well as by site." Meanwhile, a UNI ITV student said:

"Instructors make the difference in the experience when they allow interaction and decrease lecture." An example of NKNU ITV teachers' comments was: "Every site needs assistance teacher." A NKNU ITV student said: "Instructor needs to use more graphic (not words) or film to enhance teaching." Other responses are also presented in Appendix Q.

Research Question 4

Research Question 4: What are the similarities and/or differences in teacher and student demographics of the UNI and NKNU ITV programs?

The researcher designed the prior question for ITV program teachers and students to allow them to concentrate on one course in their answers. Item 01 in the teacher questionnaire: What is the name of an ITV course you have taught? The student questionnaire Item 01: What is the name of an ITV course you have taken at a remote site where students were separated from instructor? According to the respondents of the questionnaires from the teachers and students of UNI and NKNU ITV programs, at least 59 courses (see Appendix R) had been offered as UNI ITV continuing education classes before spring semester, 2000. At least 36 courses for general education (see Appendix S) had been

offered as NKNU ITV classes prior to the spring semester, 2000.

Teacher Section

The demographic information of participants in the teacher questionnaire included: (a) gender, (b) age, (c) years of teaching in university/college, (d) years of teaching ITV courses, (e) number of ITV courses which you have taught, (f) attendance at an ITV workshop or training session before teaching an ITV course, (g) number of sites which you taught in this course (including origination site). The demographic data of teacher respondents are presented in Table 8.

Similarities Among Teachers

Table 8 shows that at both schools, the modal response to the gender was male (Item 1); the modal response to the number of teaching courses was one course (Item 5); the modal response to the number of teaching sites was five sites (Item 7).

Differences Among Teachers

As seen in Table 8, a larger percentage of UNI teacher respondents were female than NKNU teacher respondents (Item 1). A larger percentage of UNI teacher respondents were over 45 years old than NKNU teacher respondents (Item 2).

Table 8

Demographic Information of Teacher Respondents of UNI and NKNU ITV Programs

| Items | UNI | | NKNU | |
|---|----------|-------|----------|-------|
| | <u>f</u> | % | <u>f</u> | % |
| 1. Gender: | | | | |
| (a) Female | 14 | 43.8% | 9 | 30.0% |
| (b) Male | 18 | 56.3% | 21 | 70.0% |
| 2. Age: | | | | |
| (a) Under 26 | 0 | 0.0% | 1 | 3.3% |
| (b) 26-35 | 2 | 6.3% | 1 | 3.3% |
| (c) 36-45 | 9 | 28.1% | 15 | 50.0% |
| (d) 46-55 | 11 | 34.4% | 13 | 43.3% |
| (e) 56-65 | 10 | 31.3% | 0 | 0.0% |
| (f) Over 65 | 0 | 0.0% | 0 | 0.0% |
| 3. Years of teaching in university/college: | | | | |
| (a) 1-5 years | 1 | 3.1% | 2 | 6.7% |
| (b) 6-10 years | 7 | 21.9% | 12 | 40.0% |
| (c) 11-15 years | 3 | 9.4% | 6 | 20.0% |
| (d) 16-20 years | 6 | 18.8% | 7 | 23.3% |
| (e) Over 20 years | 15 | 46.9% | 3 | 10.0% |
| 4. Years of teaching ITV courses: | | | | |
| (a) Under 1 year | 10 | 31.3% | 12 | 40.0% |
| (b) 1-2 years | 8 | 25.0% | 15 | 50.0% |
| (c) 3-4 years | 7 | 21.9% | 2 | 6.7% |
| (d) 5-6 years | 5 | 15.6% | 1 | 3.3% |
| (e) Over 6 years | 2 | 6.3% | 0 | 0.0% |

(table continues)

| Items | UNI | | NKNU | |
|--|----------|-------|----------|-------|
| | <u>f</u> | % | <u>f</u> | % |
| 5. How many ITV courses have you taught? | | | | |
| (a) 1 course | 12 | 37.5% | 22 | 73.3% |
| (b) 2 courses | 8 | 25.0% | 7 | 23.3% |
| (c) 3 courses | 1 | 3.1% | 1 | 3.3% |
| (d) 4 courses | 1 | 3.1% | 0 | 0.0% |
| (e) 5 courses or more | 10 | 31.3% | 0 | 0.0% |
| 6. Did you attend an ITV workshop or training session before teaching an ITV course? | | | | |
| (a) Yes | 28 | 87.5% | 4 | 13.3% |
| (b) No | 4 | 12.5% | 26 | 86.7% |
| 7. What is the number of sites you taught in this course (including origination site)? | | | | |
| (a) 2 sites | 5 | 15.6% | 2 | 6.7% |
| (b) 3 sites | 4 | 12.5% | 8 | 26.7% |
| (c) 4 sites | 4 | 12.5% | 8 | 26.7% |
| (d) 5 sites | 11 | 34.4% | 9 | 30.0% |
| (e) 6 sites | 4 | 12.5% | 1 | 3.3% |
| (f) 7 sites or more | 4 | 12.5% | 2 | 6.7% |

A larger percentage of UNI teacher respondents taught courses in the university for over 20 years than NKNU teacher respondents (Item 3). More UNI teacher respondents have taught ITV courses for over two years than NKNU teacher respondents (Item 4). More UNI teacher respondents have taught five or more ITV courses than NKNU teacher respondents (Item 5). There was a larger percentage of UNI teacher respondents who have attended an ITV workshop or training than NKNU teacher respondents (Item 6). In addition, there was a larger percentage of UNI teacher respondents who have taught at five or more sites than NKNU teacher respondents.

Student Section

The demographic information of participants in the student questionnaire were composed of (a) gender, (b) student status, (c) age, (d) number of ITV courses which you have taken. The demographic data of student participants are presented in Table 9.

Similarities Among Students

Table 9 indicates there was little similarity between the two ITV program student respondents.

Table 9

Demographic Information of Student Respondents of UNI and
NKNU ITV Program

| Items | UNI | | NKNU | |
|--|----------|-------|----------|--------|
| | <u>f</u> | % | <u>f</u> | % |
| 1. Gender: | | | | |
| (a) Female | 97 | 61.8% | 83 | 46.6% |
| (b) Male | 60 | 38.2% | 95 | 53.4% |
| 2. Student Status: | | | | |
| (a) Undergraduate Part-time | 14 | 8.9% | 0 | 0.0% |
| (b) Undergraduate Full-time | 2 | 1.3% | 178 | 100.0% |
| (c) Graduate Part-time | 114 | 72.6% | 0 | 0.0% |
| (d) Graduate Full-time | 18 | 11.5% | 0 | 0.0% |
| (e) None Credit | 1 | 0.6% | 0 | 0.0% |
| (f) Other | 8 | 5.1% | 0 | 0.0% |
| 3. Age: | | | | |
| (a) 23 or under | 1 | 0.6% | 161 | 90.4% |
| (b) 24-35 | 60 | 38.2% | 17 | 9.6% |
| (c) 36-45 | 41 | 26.1% | 0 | 0.0% |
| (d) 46-55 | 52 | 33.1% | 0 | 0.0% |
| (e) Over 55 | 3 | 1.9% | 0 | 0.0% |
| 4. How many ITV courses have you taken? | | | | |
| (a) 1 course | 16 | 10.2% | 114 | 64.0% |
| (b) 2 courses | 55 | 35.0% | 52 | 29.2% |
| (c) 3 courses | 18 | 11.5% | 10 | 5.6% |
| (d) 4 courses | 29 | 18.5% | 1 | 0.6% |
| (e) 5 courses or more | 39 | 24.8% | 1 | 0.6% |

Differences Among Students

Table 9, shows a larger percentage of UNI student respondents were female than NKNU student respondents (Item 1). A larger percentage of UNI student respondents were part-time graduate students than NKNU student respondents (Item 2). A larger percentage of UNI student respondents were over 23 years old than NKNU student respondents (Item 3). A larger percentage of UNI student respondents have taken three or more courses than NKNU student respondents (Item 4).

Summary

The data located in Appendices L, M, and N were categorized and summarized in Tables 5, 6, and 7. In addition to the Table 8 and Table 9, all the data described responses to the four research questions. The data showing similarities and differences will be discussed in the next chapter.

CHAPTER V

SUMMARY, CONCLUSIONS, AND RECOMMENDATIONS

This chapter presents three major sections: a summary, discussion and conclusions, and recommendations. The first section summarizes the information presented in the previous chapters of this study. The second section draws some conclusions based on the findings. The third section recommends several improvements and future studies.

Summary of Study

This study investigated and compared teaching methods and classroom management practices in university ITV courses in two separate world communities: the University of Northern Iowa in the United States, and the National Kaohsiung Normal University on Taiwan, an island country off the southeast coast of China. The study compared the attitudes of teachers and students toward ITV programming in these two areas and compared the demographics of teachers and students participating in the two separate ITV programs.

The following research questions were developed to guide the investigations of this study:

1. What are the similarities and/or differences in the teaching methods used in the UNI and NKNU ITV programs?

2. What are the similarities and/or differences between classroom management practices in the UNI and NKNU ITV programs?

3. What are the similarities and/or differences in teachers' and students' attitudes toward UNI and NKNU ITV programming?

4. What are the similarities and/or differences in teacher and student demographics of the UNI and NKNU ITV programs?

The survey questionnaire addressed the research questions and collected the relevant information. Part I of the questionnaire was designed to answer the Research Question 1; Part II to answer the Research Question 2; Part III to answer the Research Question 3; and, Part IV to answer the Research Question 4.

The population of this study consisted of four groups: Group One, the teachers of the UNI ITV program; Group Two, students who had remote site learning experiences in the UNI ITV program during the 1999 fall semester; Group Three, the teachers of the NKNU ITV program; Group Four, the students who had remote site learning experiences in the NKNU ITV program during the 1999 fall semester. The population name listing for this study was obtained from

the UNI Continuing Education Office and the registrar offices of the NKNU ITV programs. The name listing included 64 teachers and 413 students involved with the UNI ITV program, and 53 teachers and 717 students in the NKNU ITV program. A simple random selection procedure was used to obtain study sample subjects that included 40 teachers and 300 students of the UNI ITV program, and 40 teachers and 300 students of the NKNU ITV program. Thirty-two UNI teachers, 157 UNI students, 30 NKNU teachers, and 178 NKNU students returned the survey questionnaires for the study's total returned and usable rate of 58.4%.

Data from the questionnaire were analyzed using descriptive and inferential statistical methods: frequency, percentage, mean, two-way ANOVA and Chi-Square probability value, and effective evidence size. The frequency and percentage of response methods were used to analyze the demographic information and to understand the respondent rate at every scale of the questionnaire. The mean score, probability value, and effective evidence size were used to measure the response degree to the questionnaire questions and identify the significant difference between groups. The critical probability value of .05 was used to detect the significant difference. The statistical significance

was used to define the terms of similarity and difference in this study.

Summary of Findings

A brief list of similarities and differences between UNI and NKNU ITV programs is presented in Appendix T. The similarities between the UNI and NKNU ITV programs were as follows:

1. In both schools, there was an approximate percentage of respondents who answered that presentation software (e.g., Power Point; Table 5, Q08), problem-solving simulation (Table 5, Q10), demonstrations (Table 5, Q13), and the reviewing of previous contents (Table 5, Q16) were not used in these ITV programs.

2. They highly agreed that objectives of the course were clearly identified (Table 6, Q02), and course materials were presented in an organized way (Table 6, Q14).

3. They moderately agreed that visual teaching aids (Table 6, Q03), summarizing techniques (Table 6, Q05), overhead cameras (Table 6, Q06), presentation software (e.g., Power Point; Table 6, Q08), tests, examinations, or other assessments (Table 6, Q09), lectures (Table 6, Q12), demonstrations (Table 6, Q13), assignment discussions

(Table 6, Q17), and a variety of teaching methods (Table 6, Q18) were effectively used.

4. They weakly agreed that the World Wide Web (Table 6, Q07), ISG (Table 6, Q15) and the reviewing of previous content (Table 6, Q16) were used effectively.

5. They moderately agreed that instructional materials were provided in a timely manner (Table 6, Q19), interaction between sites was frequent (Table 6, Q20), and appropriate pacing was conducted (Table 6, Q23).

6. They highly agreed that their attitudes toward the use of ITV technology for teaching and learning (Table 6, Q26) and attitudes toward ITV courses (Table 6, Q27) were positive.

7. They moderately agreed that they felt comfortable with the ITV classes (Table 6, Q28) and were satisfied with ITV instructions (Table 6, Q29).

8. Many students responded that they disliked system breakdowns, noises, and unclear video images (Q31).

9. The modal response of ITV teachers to the gender was male (Table 8, Item 1).

10. The modal response of ITV teachers to the number of teaching courses was one course (Table 8, Item 5).

11. The modal response of ITV teachers to the number of teaching sites was five sites (Table 8, Item 7).

The differences between the UNI and NKNU ITV programs were as follows:

1. A larger percentage of UNI respondents than NKNU respondents answered that the World Wide Web (Table 5, Q07), tests, examinations, or other assessments (Table 5, Q09), and ISG (Table 5, Q15) were NOT used in ITV classes.

2. A larger percentage of NKNU than UNI respondents answered that visual teaching aids (Table 5, Q03), small-group discussions (Table 5, Q11), and a variety of teaching methods (Table 5, Q18) were NOT used in ITV classes.

3. UNI respondents moderately agreed more than NKNU respondents that questioning techniques were effectively used (Table 7, Q04). UNI respondents moderately agreed that problem-solving simulations or case studies (Table 7, Q10) and small-group discussions (Table 7, Q11) were effectively used, while NKNU weakly agreed to Q10 and weakly disagreed to Q11.

4. UNI respondents moderately agreed, while NKNU respondents weakly agreed that calling on students by name for input during class was used effectively (Table 7, Q21), students actively participated during the ITV class (Table

7, Q22), and classrooms/sites were organized and managed well (Table 7, Q25).

5. UNI respondents weakly agreed, while NKNU respondents weakly disagreed that communication between/among sites was not difficult (Table 7, Q24).

6. UNI ITV program students liked the ITV class convenience and less travel such classes required, while NKNU ITV program students liked the interactions and discussions the ITV program provided (Q30).

7. A larger percentage of UNI than NKNU teacher respondents were female (Table 8, Item 1).

8. A larger percentage of UNI than NKNU teacher respondents were over 45 years of age (Table 8, Item 2).

9. A larger percentage of UNI than NKNU teacher respondents have taught university courses for over 20 years (Table 8, Item 3).

10. A larger percentage of UNI than NKNU teacher respondents have taught ITV courses for over two years (Table 8, Item 4).

11. A larger percentage of UNI than NKNU teacher respondents have taught five or more ITV courses (Table 8, Item 5).

12. A larger percentage of UNI than NKNU teacher respondents have attended an ITV workshop or training session (Table 8, Item 6).

13. A larger percentage of UNI than NKNU teacher respondents have taught at five or more sites (Table 8, Item 7).

14. A larger percentage of UNI than NKNU student respondents were female, part-time graduate status, over 23 years of age, and had taken three or more ITV courses (Table 9, Items 1, 2, 3, and 4).

Discussions and Conclusions

The discussions and conclusions derived from the findings of this study are presented in the following section, which is divided into four parts: ITV teaching methods, ITV classroom management, attitudes toward ITV classes, and demographics.

ITV Teaching Methods

This section was divided into similarities and differences for discussion and conclusion.

Similarities

Approximately 19% of respondents in both schools said that presentation software (e.g., Power Point) was not used in the ITV course (Table 5, Q08); 11% answered that

problem-solving simulations or case studies were not used (Table 5, Q10); 11% said that demonstrations were not used (Table 5, Q13); and 6% of the respondents answered that there was no reviewing of previous course content (Table 5, Q16). So, in conclusion the survey showed some UNI and NKNU ITV teachers were not yet using presentation software (e.g., Power Point), problem-solving simulations or case studies, and demonstrations; a few teachers were not yet using content reviewing techniques. It could be inferred that some teachers were not yet familiar with these teaching methods, or possibly these methods were not appropriate for some courses.

Both schools' respondents highly agreed that objectives of the courses were clearly identified (Table 6, Q02) and course materials were presented in an organized way (Table 6, Q14). As a result the study showed that both schools' ITV teachers have done an excellent job from the beginning in clearly identifying course objectives and presenting course materials in an organized way. The study also recognized that ITV teachers have fully prepared materials for teaching before class and been familiar with ITV teaching.

Both schools' respondents moderately agreed that visual teaching aids (Table 6, Q03), summarizing techniques (Table 6, Q05), overhead cameras (Table 6, Q06), presentation software (e.g., Power Point; Table 6, Q08), tests, examinations, or other assessments (Table 6, Q09), lectures (Table 6, Q12), demonstrations (Table 6, Q13), assignment discussions (Table 6, Q17), and a variety of teaching methods (Table 6, Q18) were effectively used. It can be inferred from this information that UNI and NKNU teachers have effectively used these teaching methods in ITV classes. It could also mean that UNI and NKNU ITV teachers have mastered these teaching methods in ITV classes.

Both schools' respondents only weakly agreed that the World Wide Web (Table 6, Q07), ISG (Table 6, Q15) and reviewing previous course content (Table 6, Q16) were effectively used in the ITV programs. This indicated that both schools' ITV program teachers less effectively used the World Wide Web, the Interactive Study Guide (ISG), and course reviewing techniques. However, this could also mean that the teachers were not yet familiar with using the World Wide Web and ISG. Or, possibly these methods were not appropriate for their courses.

Differences

A larger percentage of UNI than NKNU respondents said that the following were NOT used in ITV classes: World Wide Web (36.7% UNI; 18.3% NKNU; Table 5, Q07); tests, examinations, or other assessments (13.8% UNI; 5.3% NKNU; Table 5, Q09); and ISG (50.8% UNI; 16.3% NKNU; Table 5, Q15). This indicated more UNI ITV teachers than NKNU ITV teachers have NOT yet used the World Wide Web, tests, examinations, or other assessments, and ISG. It could be inferred that these methods were NOT available for some UNI ITV courses more often than they were for NKNU ITV courses.

A larger percentage of NKNU respondents than UNI respondents answered that visual teaching aids (9.0% NKNU; 2.6% UNI; Table 5, Q03); small-group discussion (14.4% NKNU; 2.6% UNI; Table 5, Q11); and a variety of teaching methods (9.6% NKNU; 1.0% UNI; Table 5, Q18) were NOT used in ITV classes. This indicated more NKNU ITV teachers than UNI ITV teachers have NOT yet used visual teaching aids, small-group discussions, and a variety of teaching methods. It could also mean that a few NKNU ITV teachers did NOT like to use these methods, or they were not appropriate to them.

UNI respondents moderately agreed more than NKNU respondents that questioning techniques were effectively used (Table 7, Q04). UNI respondents moderately agreed that problem-solving simulations or case studies (Table 7, Q10) and small-group discussions (Table 7, Q11) were effectively used, while NKNU weakly agreed to Q10, and weakly disagreed to Q11. UNI mean scores were higher than those of NKNU respondents. This showed that UNI ITV teachers were more familiar with using questioning techniques, problem-solving simulations or case studies, and small-group discussions than NKNU ITV teachers use. NKNU ITV teachers may want to try and imitate these UNI teachers' approaches. However, the UNI results could also mean that NKNU ITV students shied away from active participation and discussions, or possibly NKNU students didn't like to see themselves on the TV screen. On the other hand, possibly these methods were not available for teachers to use in the NKNU ITV classes.

ITV Classroom Management

Similarities and differences were discussed and concluded as follows.

Similarities

Both schools' respondents moderately agreed that instructional materials were provided in a timely manner (Table 6, Q19), interaction between sites was frequent (Table 6, Q20), appropriate pacing was conducted (Table 6, Q23). This indicated that both UNI and NKNU ITV teachers managed the ITV classroom well.

Differences

UNI respondents moderately agreed while NKNU respondents weakly agreed that calling on students by name for input in class was used effectively (Table 7, Q21), students actively participated in the ITV class (Table 7, Q22), and classroom/sites were organized and managed well (Table 7, Q25). These findings showed that UNI ITV teachers were more familiar than NKNU ITV teachers were with calling on students by their names, and keeping the classroom/sites organized. In addition, UNI ITV students were more used to active participation in class than NKNU students. NKNU ITV teachers and students may want to imitate such ITV classroom behaviors.

UNI respondents weakly agreed while NKNU respondents weakly disagreed that communication between/among sites was not difficult (Table 7, Q24). Possibly communication in

NKNU ITV classes was more difficult than in UNI ITV classes. Both schools should enhance such communications.

Attitudes Toward ITV Classes

There were no statistical significant differences between UNI and NKNU ITV teachers and students. Therefore, in this part, similarities and open-end questions were discussed and concluded.

Similarities

Both schools' respondents highly agreed that their attitudes toward the use of ITV technology for teaching and learning (Table 6, Q26) and the attitudes toward ITV courses (Table 6, Q27) were positive; they moderately agreed that they felt comfortable with the ITV classes (Table 6, Q28); and, were satisfied with ITV instructions (Table 6, Q29). These results showed that all ITV teachers and students liked ITV classes and ITV distance learning.

Open-End Questions

The open-end question data (Appendix O, Appendix P, and Appendix Q) showed that UNI and NKNU ITV teachers and students liked the convenience, reduced travel, discussions, and interactions, which accompanied ITV classes. They disliked the ITV system when it experienced

breakdowns, including extraneous sounds and noises, and projected unclear images.

Demographics

According to the Appendix R and Appendix S, at least UNI ITV program has offered 59 courses and NKNU ITV program has offered 36 courses. It indicated that UNI ITV classes tended to offer the courses in education, psychology, and school administration. It also indicated that NKNU ITV classes tended to offer courses in health and living.

Discussion and conclusion in the demographics were divided into teacher section and student section.

Teacher Section

Similarities and differences were discussed and concluded in this section.

Similarities. On Table 8, Item 1, the modal response to the gender was male. It indicated that in these two ITV classes male teachers were more than females. On Item 5, both schools' modal response to the number of teaching courses was one course. It indicated that more teachers have taught just only one ITV course. On Item 7, both schools' modal response to the number of teaching sites was five sites (including origination site). It indicated that five sites were popular for every ITV courses.

Differences. A larger percentage of UNI than NKNU teacher respondents were over 45 years of age (Table 8, Item 2). A larger percentage of UNI than NKNU teacher respondents have taught university courses for over 20 years (Table 8, Item 3). A larger percentage of UNI than NKNU teacher respondents have taught ITV courses over two years (Table 8, Item 4). A larger percentage of UNI than NKNU teacher respondents have taught five or more ITV courses (Table 8, Item 5). A larger percentage of UNI than NKNU teacher respondents have attended an ITV workshop or training session (Table 8, Item 6). A larger percentage of UNI than NKNU teacher respondents have taught at five or more sites (Table 8, Item 7). These findings showed that UNI ITV teachers had more ITV teaching experiences than NKNU ITV teachers. Therefore, this study could infer that the UNI ITV program (1993-2000) had accrued more familiarity with such distance learning systems than NKNU ITV program (1997-2000) had to date.

Student Section

There were no similarities between UNI and NKNU ITV students. Therefore, only differences were discussed and concluded.

Differences. On Table 9, Item 1, the percentage of UNI female ITV student respondents was larger than of NKNU female ITV student respondents. On Item 2, the modal response of UNI ITV students to the statuses was graduate part-time while the modal response of NKNU ITV students was undergraduate full-time. On Item 3, the percentage of UNI ITV student respondents who were over 24 years old was larger than of NKNU ITV student respondents. On Item 4, the percentage of UNI ITV student respondents who have taken three or more courses was larger than of NKNU ITV student respondents. These cases above indicated that many UNI ITV students were female, adult, at part-time graduate statuses, at least taking three or more continuing education courses in ITV programs. It also indicated that many NKNU ITV students were, male, young, at full-time undergraduate statuses, and taking no more than three ITV courses.

Recommendations

This section is divided into three parts: first, the recommendation for the UNI ITV program; second, the recommendation for the NKNU ITV program; and, third the recommendation for future study.

Recommendations for UNI ITV Program

Based on the findings, discussions and conclusions of this study, the answering of "not used" items and "weakly agree" items should be enhanced. Some recommendations are provided as follows.

If it is available and relevant to the course, some UNI ITV program teachers should try to become more familiar with, or enhance their use of the World Wide Web (WWW), presentation software (e.g., Power Point), tests, examinations, or other assessments, problem-solving simulations or case studies, demonstrations, the Interactive Study Guide (ISG), and reviewing course content in ITV classes.

The UNI ITV program providers, ICN, if possible, should enhance the communication between/among sites, try and avoid system breakdowns, extraneous noise and sounds, and project clear video images during ITV class.

If possible, ICN should strive to provide standard equipment and environments at their remote ITV sites and expand the number of classes offered.

Recommendations for NKNU ITV Program

If available and relevant for the course, some NKNU ITV teachers should try to employ and enhance their visual

teaching aids, use of the World Wide Web, presentation software (e.g., Power Point), tests, examinations, or other assessments, problem-solving simulations or case studies, small-group discussions, demonstrations, the Interactive Study Guide (ISG), course content reviews, and generally incorporate a variety of teaching methods in their ITV classes.

The NKNU ITV program instructors should attempt to call students by name when asking for input, encourage students to actively participate, and attempt to better organize and manage classroom sites. The NKNU ITV program providers, Taiwan distance learning network, should attempt to make the communication between/among sites less difficult, avoid system breakdowns, extraneous noise and sound, and provide clear video images.

Recommendations for Future Study

Based on this study, some of the following recommendations for future study were made.

1. Focus a study on investigating which teaching methods are better suited for ITV instruction.
2. A future study could investigate the differences of teaching methods in ITV classes and traditional classes.

3. A future study could investigate the reasons why many ITV teachers didn't use the Interactive Study Guide (ISG), the World Wide Web, and presentation software (e.g., Power Point) in their teaching.

4. A future study could try and determine the reasons why many NKNU ITV program teachers didn't take workshops or training sessions before they taught an ITV course.

5. A future study could examine the benefits and advantages that ITV classes offer.

6. This study should be replicated to verify its results.

REFERENCES

- Alreck, L. P., & Settle, R. B. (1995). The survey research handbook (2nd ed.). Chicago: Richard D. Irwin, Inc.
- Arends, R. I., Winitzky, N. E., & Tannenbaum, M. D. (1998). Exploring teaching. Boston: McGraw-Hill Companies, Inc.
- Ary, D., Jacobs, L. C., & Razavieh, A. (1990). Introduction to research in education (4th ed.). Orlando, FL: Holt, Rinehart and Winston, Inc.
- Babbie, E. (1990). Survey research methods (2nd ed.). Belmont, CA: Wadsworth, Inc.
- Barker B. O., & Dickson, M. W. (1996). Distance learning technologies in K-12 schools: Past, present, and future practice. Tech Trends, 41(6), 19-22.
- Barker, B., Frisbie, A., & Patrick, K. (1989). Broadening the definition of distance education in the light of the new telecommunications technologies. The American Journal of Distance Education, 3(1), 20-29.
- Behling, J. H. (1976). Research methods: Statistical concepts and research practicum. Millburn, NJ: RF Publishing, Inc.
- Brown, R. H. (chair). (1993). The national information infrastructure: Agenda for action. Washington, DC: Executive Office of the president. U.S. Documents PREX 1.2:IN 3
- Cangelosi, J. S. (1997). Classroom management strategies: Gaining and maintaining students' cooperation (3rd ed.). New York: Longman.
- Charles, C. M. (1998). Introduction to educational research (3rd ed.). New York: Longman.
- Charles, C. M., & Senter, G. W. (1995). Elementary classroom management (2nd ed.). New York: Longman.

- Chavkin, N. F., Kennedy, P. A., & Carter, M. (1994). Distance learning partnerships for under-served learners. Tech Trends, 39(5), 30-38.
- Chen, L. L. (1997). Distance delivery system in terms of pedagogical considerations: A reevaluation. Educational Technology, 37(4), 34-37.
- Chute, A. G., Thompson, M. M., & Hancock, B. W. (1999). The McGraw-Hill handbook of distance learning. New York: McGraw-Hill.
- Collins, M. L. (1978). Effects of enthusiasm training on pre-service elementary teachers. Journal of Teacher Education, 29(1), 53-57.
- Connick, G. P. (Ed.). (1999). The distance learner's guide. Upper Saddle River, NJ: Prentice-Hall, Inc.
- Conti, G. J. (1998). Identifying your teaching style. In M. W. Galbraith (Ed.), Adult learning methods: A guide for effective instruction (2nd ed., pp. 73-89). Malabar, FL: Robert E. Krieger Publishing Co., Inc.
- Cyrs, T. E. (1989). Designing a teleclass instructor's workshop: Addressing the differential skills needed for quality teleclass teaching. Fifth Annual Conference on Teaching at a Distance, 178-180. (ERIC Document Reproduction Service No. ED 315 551)
- Cyrs, T. E. (Ed.). (1997). Competence in teaching at a distance. In T. Cyrs (Ed.), Teaching and learning at a distance: What it takes to effectively design, deliver, and evaluate programs (pp. 15-18). San Francisco: Jossey-Bass Inc.
- Cyrs, T. E., & Conway, E. D. (1997). Teaching at a distance with the merging technologies: An instructional systems approach. Las Cruces: New Mexico State University, Center for Education Development.
- Dede, C. (1996). The evolution of distance education: Emerging technologies and distributed learning. The American Journal of Distance Education, 10(2), 4-36.

- Dejnozka, E. L., & Kapel, D. E. (1991). American educator's encyclopedia. New York: Greenwood press.
- Duran, J., & Sauer, C. (1997). Mainstream videoconferencing: A developer's guide to distance multimedia. Reading, MA: Addison-Wesley Publishing Company.
- Egan, M. W., & Gibb, G. S. (1997). Student-centered instruction for the design of telecourses. In T. E. Cyrs (Ed.), Teaching and learning at a distance: What it takes to effectively design, deliver, and evaluate programs (pp. 33-39). San Francisco: Jossey-Bass Inc.
- Fraenkel, J. R., & Wallen, N. E. (1996). How to design and evaluate research in education. New York: McGraw-Hill, Inc.
- Froyen, L. A., & Iverson, A. M. (1999). School wide and classroom management: The reflective educator leader (3rd ed.). Upper Saddle River, NJ: Merrill.
- Fry, J., Medsker, K., & Bonner, D. (1996). Teaching methods and strategies. In V. Bianco-Mathis & N. Chalofsky (Eds.), The adjunct faculty handbook (pp. 55-114). Thousand Oaks, CA: SAGE Publications, Inc.
- Gall, M. D., Borg, W. R., & Gall, J. P. (1996). Educational research: An instruction (6th ed.). New York: Longman.
- Garrison, D. R. (1989). Understanding distance education: A framework for the future. New York: Routledge.
- Garrison, D., & Shale, D. (1987). Mapping the boundaries of distance education: Problems in defining the field. The American Journal of Distance Education, 1(1), 4-13.
- Gold, B. L. (1997). A formative evaluation of a distance learning program at CSUDH (Doctoral dissertation, Pepperdine University, 1997). Dissertation Abstracts International, 58(11), 4203A.

- Goro, T. D. (1995). The identification and analysis of factors perceived as important to the success of interactive distance education (Doctoral dissertation, University of Northern Iowa, 1995). Dissertation Abstracts International, 56(7), 2648A.
- Gove, P. B. (Ed.). (1993). Webster's third new international dictionary of the English language unabridged. Springfield, MA: Merriam-Webster, Inc.
- Hanson, D., Maushak, N. J., Schlosser, C. A., Anderson, M. L., Scorensen, C., & Simonson, M. (1996). Distance education: Review of the literature (2nd ed.). Ames: Iowa State University, Research Institute for Studies in Education, College of Education.
- Hardman, R. R. (1999). Interactive Television Workshop. (Available from Center for Educational Technology, University of Northern Iowa, Cedar Falls, IA 50614)
- Harry, K., John, M., & Keegan, D. (Eds.). (1993). Distance education: New perspectives. New York: Routledge.
- Hefzallah, I. M. (1999). The new educational technologies and learning. Springfield, IL: Charles C. Thomas Publisher, Ltd.
- Heinich, R., Molenda, M., Russell, J. D., & Smaldino, S. E. (1999). Instructional media and technologies for learning (6th ed.). Upper Saddle River, NJ: Prentice-Hall, Inc.
- Herring, M. C., & Smaldino, S. E. (1998). Planning for interactive distance education: A handbook. Washington, DC: Association for Education Communications and Technology.
- Hewit, J. S., & Whittier, K. S. (1997). Teaching methods for today's schools: Collaboration and inclusion. Boston: Allyn & Bacon.

- Hilgenberg, C. S. (1997). Distance education: Perceptions of satisfaction and critical thinking opportunities among graduate students (Doctoral dissertation, Illinois State University, 1997). Dissertation Abstracts International, 58(7), 2610A.
- Hittleman, D. R., & Simon, A. J. (1997). Interpreting educational research: An introduction for consumers of research. New York: Macmillan Publishing Company.
- Hobbs, V. M., & Christianson, J. S. (1997). Virtual classrooms: Educational opportunity through two-way interactive television. Lancaster, PA: Technomic Publishing Company, Inc.
- Hurlburt, R. T. (1998). Comprehending behavioral statistics (2nd ed.). New York: Brook/Cole Publishing Company.
- ICN (Iowa Communications Network). (1999). The ICN story. Iowa Communications Network [On-line]. Available: <http://www.icn.state.ia.us/about/story/facts.html>
- Iowa Database. (1999). Iowa communications network. Iowa communications network [On-line]. Available: http://www3.iptv.org/iowa_database/icn/icn.html
- Kameenui, E. J., & Darch, C. B. (1995). Instructional classroom management: A productive approach to behavior management. New York: Longman.
- Keegan, D. (1983). On defining distance education. In D. Sewart, D. Keegan, & B. Holmbers (Eds.), Distance education: International perspectives (pp. 6-33). New York: Routledge.
- Keegan, D. (1995). Distance education technology for the new millennium: Compressed video teaching. (ERIC Document Reproduction Service No. ED 389 931)
- Keegan, D. (1996). The foundation of distance education (3rd ed.). New York: Routledge.

- Kommers, P. A. M., Grabinger, S., & Dunlap, J. C. (Eds.). (1996). Hypermedia learning environments: Instructional design and integration. Mahwah, NJ: Lawrence Erlbaum Associates.
- Lin, C. S. (1993). Statistics in psychology and education. Taipei, Taiwan: Dong Hwa Press, Inc.
- Litwin, M. S. (1995). How to measure survey reliability and validity. Thousand Oaks, CA: SAGE Publications, Inc.
- Lochte, R. H. (1993). Interactive television and instruction. Englewood Cliffs, NJ: Educational Technology Publications, Inc.
- Ludlow, B. L., & Duff, M. C. (1998). Distance education and tomorrow's school. Bloomington, IN: Phi Delta Kappa Education Foundation.
- Ma, N. S. (1997). The status and future development of ROC distance learning in the project of National Information Infrastructure. Distance Education (in Taiwan), 1, 7-10.
- Ministry of Education of R.O.C. (1996). Distance learning 4-year developing program. Taipei, Taiwan: Ministry of Education.
- Mitchasson, L. (1997). Continuing education. Management Accounting, 79(2), 72.
- Moore, K. D. (1998). Classroom teaching skills (4th ed.) Boston: McGraw-Hill Companies, Inc.
- Moore, M. (1990). Background and overview of contemporary American distance education. In M. Moore (Ed.), Contemporary issues in American distance education (pp. xii-xxvi). New York: Pergamon Press.
- Moore, M. G., & Kearsley, G. (1996). Distance education: A systems view. Belmont, CA: Wadsworth Publishing Company.

- Moore, M. G., Thompson, M. M., Quigley, B. A., Clark, G. C., & Goff, G. G. (1990). The effects of distance learning: A summary of literature. (Number 2 in the series Research Monograph). University Park: The Pennsylvania State University, American Center for the Study of Distance Education.
- Nasseh, B. (1996). A study of computer-based distance education in higher education institutions in Indiana (Doctoral dissertation, Ball State University, 1996). Dissertation Abstracts International, 57(10), 4287A.
- Nelson, G. W. (1997). A measurement of attitudes of Bureau of Land Management employees toward distance learning (Doctoral dissertation, University of Idaho, 1997). Dissertation Abstracts International, 58(10), 3803A.
- Newble, D., & Cannon, R. (1991). A handbook for teachers in universities & colleges: A guide to improving teaching methods. London: Kogan Page.
- Office of Technology Assessment of U.S. Congress. (1989). Linking for learning: A new course for education (OTA-SET-430). Washington, DC: U.S. Government Printing Office. (ERIC Document Reproduction Service No. ED 310 765)
- Olson, F., & Hall, T. J. K. (1997). Developing distance learning curricula: Adaptation or innovation? Proceedings of the Fourteenth International Conference on Technology and Education, Vol. 2, 367-369. August 10-13, 1997, Oslo, Norway.
- Opie, R. H. (1998). Iowa Communications Network annual report fiscal year 1998. Iowa Communications Network [On-line]. Available: <http://www.icn.state.ia.us/annual.pdf>
- Park, L. A., & Monson, M. K. (1980). Teletechniques: An instructional model for interactive teleconferencing. The Directional Design Library, V.38. Englewood Cliffs, NJ: Educational Technology Publications Inc.

- Parks, S. C. (1997). A study of the importance of customer satisfaction on students' intent to remain in a distance education degree program (Doctoral dissertation, The Pennsylvania State University, 1997). Dissertation Abstracts International, 58(7), 2562A.
- Peters, O. (1993). Understanding distance education. In K. Harry, M. John, & D. Keegan (Eds.), Distance education: New perspectives (pp. 10-18). New York: Routledge.
- Rueschman, R. J. (1998). Student perception of the effectiveness of alternative distance education strategies (Doctoral dissertation, Northern Arizona University, 1998). Dissertation Abstracts International, 59(3), 794A.
- Rumble, G. (1989). On defining distance education. The American Journal of Distance Education, 3(2), 8-21.
- Schlosser, C. A., & Anderson, M. L. (1994). Distance education: Review of the literature. Ames: Iowa State University, Research Institute for Studies in Education, College of Education.
- Schuman, H., & Presser, S. (1996). Questions and answers in attitude surveys, experiments on question form, wording and context. Thousand Oaks, CA: SAGE Publications, Inc.
- Silvernail, D. L., & Johnson, J. L. (1992). The impact of interactive televised instruction on student evaluations of their instructors. Educational Technology, 32(6), 47-50.
- Simonson, M. R. (1994). Overview of the Teacher Education Alliance, Iowa Distance Education Alliance Research Plan. In M. R. Simonson, C. Schlosser, & M. Anderson (Eds.), Encyclopedia of distance education research in Iowa (pp. 1-6). Ames: Iowa State University, Research Institute for Study in Education, College of Education.

- Simonson, M., & Schlosser, C. (1995). More than fiber: Distance education in Iowa. Tech Trends, 40(3), 13-15.
- Stephens, M. D. (1994). Teaching methods for adults. In T. Husen & T. N. Postlethwaite (Eds.), The international encyclopedia of education (2nd ed., Vol 10, pp. 6198-6202). Tarrytown, NY: Elsevier Science Ltd.
- Suave, L. (1993). What's behind the development of a course on the concept of distance education? In D. Keegan (Ed.), Theoretical principles of distance education (pp. 93-109). New York: Routledge.
- Sullivan, M. (1998). Analysis of student field dependent status, attitude toward the technology medium, and perception of interaction in a distance education setting: Implications for improving the quality of distance education. Paper presented at the conference for the Louisiana Educational Research Association, March 1998. (ERIC Document Reproduction Service No. ED 419 532)
- Thach, E. C. (1994). Perceptions of distance education experts regarding the roles, outputs, and competencies needed in the field of distance education (Doctoral dissertation, Texas A&M University, 1994). Dissertation Abstracts International, 55(10), 3166A.
- Tuckman, B. W. (1988). Conducting educational research (3rd ed.). Orlando, FL: Harcourt Brace Jovanovich, Inc.
- Verduin, J. R., & Clark, T. A. (1991). Distance education: The foundations of effective practice. San Francisco: Jossey-Bass Inc.
- Wagner, E. D. (1995). Distance education success factors. Adult Learning, 7, 18-19.

- Wagner, E. D. (1997). Interactivity: From agents to outcomes. In T. Cyrs (Ed.), Teaching and learning at a distance: What it takes to effectively design, deliver, and evaluate programs (pp. 19-26). San Francisco: Jossey-Bass Inc.
- Walsh, S. M. (1993). Attitudes and perceptions of university faculty toward technology based distance education (Doctoral dissertation. The University of Oklahoma, 1993). Dissertation Abstracts International, 54(3), 781A.
- Webster, J , & Hackley, P. (1997). Teaching effectiveness in technology-mediated distance learning. Academy of Management Journal, 40(6), 1282-1309.
- Wheeler, C., Batchelder, A., & Hampshire, M. (1996). The instructional practices of televised distance education at Northern Arizona University. Education, 117(2), 172-179.
- Wiersma, W. (1995). Research methods in education: An introduction (6th ed.). Needham Heights, MA: A Simon and Schuster Company.
- Yang, C. S. (1996). Perspectives of distance instruction in the context of the National Information Infrastructure. Instructional Technology and Media (in Taiwan), 25, 50-57.
- Yin, C. H. (1999). The current situation of distance learning program of Ministry of Education. Available: <http://www.edu.tw/moecc/art/8609/8609a7.htm>
- Zigerell, J. (1991). The uses of television in American higher education. New York: Praeger.

APPENDIX A

DEFINITION OF TERMS

Attitude

Attitude has been defined as a persistent disposition to act either positively or negatively toward an object, situation, or value (Gove, 1993). Schuman and Presser (1996) defined attitude as "opinions, beliefs, values, preferences, and so on" (p. 2).

Classroom Management

Classroom management is meant to handle and direct classroom teaching so that it can run as smoothly as possible (Charles & Senter, 1995). The elements of ITV classroom management are times, behaviors of teacher and student, and instruction businesses.

Distance Education

Distance education implies a formal, institutional-based educational course, where the teacher and learner are normally separated in space and/or in time (Simonson & Schlosser, 1995).

Document Camera

Document camera is a television camera placed on the instructor's table in the ITV classroom. It can pick up the pictures, graphics, documents, or notes written by the instructor in real time. It can narrow the field of view to appear larger on the screen at the remote site using a

zoom lens. Its functions are the same as overhead camera (Cyrs & Conway, 1997; Hobbs & Christianson, 1997).

Fiber Optics

Fiber optics is a medium which uses pulses of light through glass fibers to transmit audio, video, and computer information in digital form (Hobbs & Christianson, 1997; Moore & Kearsley, 1996).

Integrated Services Digital Network

Integrated Services Digital Network (ISDN) is a set of digital telephone standard. ISDN can transmit digital signals of data, voice, and images over existing telephone copper wire lines at transfer rates up to 128 Kbps (kilobits/second) (Cyrs & Conway, 1997; Hobbs & Christianson, 1997).

Interactive Study Guide

An Interactive Study Guide (ISG) is a special teleclass guide for students consisting of a highly organized set of student notes. It is composed of displays and made up of pictures, graphics, graphs, geometric shapes, charts, clip art, photographs, exercises, activities, and problems. ISG can help students take notes easily and understand the telelesson structure clearly (Cyrs, 1997; Hardman, 1999).

Interactive Television

Interactive Television (ITV) is a highly visual and interactive kind of television system that can be used for direct classroom instruction (Cyrus, 1997). ITV can operate as one-way video and two-way audio interactions and two-way video and audio interactions. Two-way interactive television includes the two-way transmission of video and audio signals from an origination site to one or more remote sites. Teacher and students can communicate in a two-way interactive system immediately. Students and teacher can both see and hear each other at all times (Harry, John, & Keegan, 1993; Hobbs & Christianson, 1997).

Iowa Communication Network

Iowa Communication Network (ICN) is a statewide, state-administered fiber optics telecommunication network designed to transport high quality two-way, full-motion, interactive video, data and audio signals. The construction of ICN began in 1991 and became operational in 1993. Currently, there are 705 full-motion video sites connected to the network throughout the 99 counties of Iowa using 3,000 miles of DS-3 fiber optic cable. The authorized users of the network include K-12 school districts, higher education institutions, state and federal

agencies, intermediate service agencies, the Iowa National Guard, public libraries, the United State Post Office, and hospital (Goro, 1995; ICN, 1999; Iowa database, 1999; Olson & Hall, 1997; Simonson, 1994; Simonson & Schlosser, 1995).

Opie (1998), chairperson of Iowa Telecommunications and Technology Commission, reported that ICN vision was "to improve the quality of life for Iowans through advanced telecommunications services to authorized users in education, government justice, and medicine by providing, at a reasonable cost, equal access to a state-of-the-art technology platform" (p. 1). Opie also reported that the ICN mission was "to provide authorized users the highest quality and technologically advanced educational, medical, judicial, and governmental telecommunications services" (p. 1).

Instructional Television Fixed Service

Instructional Television Fixed Service (ITFS) is a transmission of a television signal via microwave radiation. Usually, it is limited to regional areas of 25-to-35 mile radius (Cyrs & Conway, 1997; Hobbs & Christianson, 1997; Moore & Kearsley, 1996).

National Kaohsiung Normal University ITV Program

The National Kaohsiung Normal University (NKNU) ITV program began in 1997 and collaborated with other universities and colleges to be both an origination site and a remote site. Students can enroll in any courses offered by the universities and colleges in the ITV programs. There were at least 7 universities collaborating with NKNU ITV program. In the near future, there will be more universities or colleges to collaborate with each other in the ITV programs. The term of NKNU defined to represent the collaborated schools.

Origination Site

Origination site is a teleclassroom where the instructor is stationed and a telecourse is initially disseminated to the remote sites. Origination site can send and receive telecommunications signal and communicate with remote site via interactive television technology (Cyrs & Conway, 1997; Goro, 1995).

Overhead Camera

Overheard camera is a television camera located in the ceiling of the ITV classroom straight over the instructor's desk. Its functions are the same as document camera (Cyrs & Conway, 1997; Hobbs & Christianson, 1997).

Remote Site

Remote site is a teleclassroom where the instructor is physically absent and a telecourse is received from origination site via television. Remote site can receive telecommunication signal and communicate with origination site via interactive television technology. Remote site may be far away from origination site on location.

Similarity

Similarity means the condition of being similar. It also means that the mean scores or percentages are no statistical significant differences.

T-1 Line

T-1 line is a telecommunication line which transmits digital signal data at a speed of 1.544 Mbps (Megabits/second). This is equal to 24 telephone lines with copper. It is also known as DS-1 (Digital Signal Level 1; Cyrs & Conway, 1997; Hobbs & Christianson, 1997).

T-3 Line

T-3 line is a telecommunication line which transmits digital signal data at a speed of 44.736 Mbps. It is also known as DS-3 (Cyrns & Conway, 1997; Hobbs & Christianson, 1997).

Teaching Method

Teaching method is a way of instruction, technique, or process that enhances learning. Traditional teaching methods include the lectures, discussions, demonstrations, etc. At present, interactive television and computer-assisted instruction methods are used for distance learning (Dejnozka & Kapel, 1991).

Traditional Class

A traditional class is a formal classroom-based instruction system used in a school setting, where teacher and students are physically present at the same time, in the same place, and communicate in a real, face-to-face manner (Hanson et al., 1996).

APPENDIX B

EXPERTS INFORMATION

Expert Name: Dr. Robert R. Hardman

Title: Professor and Director Emeritus

Institution: Information Technology Services
Educational Technology
University of Northern Iowa

Expert Name: Dr. Charles D. Johnson

Title: Professor

Institution: Department of Industrial Technology
University of Northern Iowa

Expert Name: Dr. Teresa J. K. Hall

Title: Assistant Professor

Institution: Department of Industrial Technology
University of Northern Iowa

Expert Name: Dr. Terry D. Goro

Title: Coordinator

Institution: Instructional Technology Services
University of Northern Iowa

APPENDIX C

PERMISSION FOR HUMAN SUBJECT



February 9, 2000

Mr. Richard Chang
1513 W 30th Street
Cedar Falls, IA 50613

Dear Mr. Chang:

Your project, "An Analysis of Current Instructional Practices at Selected Universities Utilizing Interactive Television Technology," which you submitted for human subjects review on February 4, 2000, has been determined to be exempt from further review under the guidelines stated in the UNI Human Subjects Handbook. You may commence participation of human research subjects in your project.

Your project need not be submitted for continuing review unless you alter it in a way that increases the risk to the participants or you change the subject pool. If you make any such changes in your project, you should notify the Graduate College office.

If you decide to seek federal funds for this project, it would be wise not to claim exemption from human subjects review on your application. Should the agency to which you submit the application decide that your project is not exempt from review, you might not be able to submit the project for review by the UNI Institutional Review Board within the federal agency's time limit (30 days after application). As a precaution against applicants' being caught in such a time bind, the Board will review any projects for which federal funds are sought. If you do seek federal funds for this project, please submit the project for human subjects review no later than the time you submit your funding application.

If you have further questions about the Human Subjects Review system, please contact me. Best wishes for your project.

Sincerely

A handwritten signature in black ink, appearing to read "Norris M. Durham".

Norris M. Durham, Ph.D.
Chair, Institutional Review Board

Voffice/humansub.fm

c: Dr. David A. Walker, Associate Dean
Dr. John Fecik

APPENDIX D

REQUEST UNI TEACHERS AND STUDENTS

FOR PARTICIPATING RESEARCH

REQUEST UNI TEACHERS AND STUDENTS
FOR PARTICIPATING RESEARCH

February 21, 2000

Dear Participant:

How are you!

You are being asked to be a research participant. Your participation is voluntary with no penalty or loss of benefits for refusal.

Would you please answer the anonymous questionnaire that relates to my dissertation: "An analysis of current instructional practices at selected universities utilizing interactive television technology." The purpose of the questionnaire is to collect data and to compare UNI and Taiwan interactive television (ITV) programs. Your responses are very important to my study. Your responses will be held in strictest confidence. Please complete the attached questionnaire prior to March 6, 2000 and return it in the stamped, addressed envelope enclosed. Upon completion of the study, the questionnaire will be destroyed. If you are interested in the summary of the results, please check and return the note enclosed. It will be mailed to you by the end of August 2000.

The return envelope has a number which will enable me to check your name off the mailing list when the questionnaire is returned. Then the envelope will be destroyed.

If you have any questions, please feel free to contact me, or my advisor, Dr. John T. Fecik, at (319) 273-2489, or the Human Subjects Coordinator at (319) 273-2748.

Your cooperation is greatly appreciated.

Sincerely yours,

Richard Shengmao Chang
D.I.T. Candidate
Department of Industrial Technology
U.N.I.

Dr. John T. Fecik
Advisor

Address: 1518 W. 30th St.
Cedar Falls, IA 50613
Telephone: (319) 222-5815
Email: Changr9616@uni.edu

APPENDIX E

INTERACTIVE TELEVISION (ITV) PROGRAM

TEACHER QUESTIONNAIRE

Interactive Television (ITV) Program Teacher Questionnaire

Thank you for taking the time to help me. There are no right or wrong answers. **Please answer the following questions and circle the number or letter** which most closely indicates your feeling about each statement. Please choose only one response for each item.

| | | | | | |
|-------------------|----------|-----------|---------|----------------|---------------------------------|
| (SD) | (D) | (U) | (A) | (SA) | (N) |
| 1 _____ | 2 _____ | 3 _____ | 4 _____ | 5 _____ | N |
| Strongly Disagree | Disagree | Undecided | Agree | Strongly Agree | Not Applicable (Or Not Used) |

01. What is the name of an ITV course you have taught? (Please list only one course)

Part I
Teaching Methods

| In my ITV class | SD | D | U | A | SA | N |
|--|----|---|---|---|----|---|
| 02. Objectives of the course were identified clearly at the beginning. | 1 | 2 | 3 | 4 | 5 | N |
| 03. Visual teaching aids (e.g., pictures, photographs, models, maps, or charts which were not from Power Point, etc.) were effectively used to explain concepts. | 1 | 2 | 3 | 4 | 5 | N |
| 04. Questioning techniques were used effectively. | 1 | 2 | 3 | 4 | 5 | N |
| 05. Summarizing techniques were used effectively. | 1 | 2 | 3 | 4 | 5 | N |
| 06. The overhead camera (document camera) was used effectively. | 1 | 2 | 3 | 4 | 5 | N |
| 07. World Wide Web (WWW) was used effectively. | 1 | 2 | 3 | 4 | 5 | N |
| 08. Presentation software (e.g., Power Point) programs were used effectively. | 1 | 2 | 3 | 4 | 5 | N |
| 09. Tests, examinations, or other assessments were used effectively. | 1 | 2 | 3 | 4 | 5 | N |
| 10. Problem-solving simulations or case studies were used effectively. | 1 | 2 | 3 | 4 | 5 | N |
| 11. Small-group discussions were used effectively. | 1 | 2 | 3 | 4 | 5 | N |
| 12. Lectures were used effectively. | 1 | 2 | 3 | 4 | 5 | N |
| 13. Demonstrations were used effectively. | 1 | 2 | 3 | 4 | 5 | N |
| 14. Course materials were presented in an organized way. | 1 | 2 | 3 | 4 | 5 | N |
| 15. Interactive Study Guides (ISG) were used effectively. | 1 | 2 | 3 | 4 | 5 | N |

Please continue on next page

| In my ITV class | S | D | U | A | SA | N |
|--|----------|----------|----------|----------|-----------|----------|
| 16. Reviewing of the previous contents at the beginning of the class was used effectively. | 1 | 2 | 3 | 4 | 5 | N |
| 17. Assignments were clearly presented and discussed during class time. | 1 | 2 | 3 | 4 | 5 | N |
| 18. A variety of teaching methods was used effectively. | 1 | 2 | 3 | 4 | 5 | N |

Part II**Classroom Management**

| In my ITV Class | SD | D | U | A | SA | N |
|---|-----------|----------|----------|----------|-----------|----------|
| 19. Instructional materials and/or other handouts were provided in timely manner. | 1 | 2 | 3 | 4 | 5 | N |
| 20. Interaction between sites was frequent. | 1 | 2 | 3 | 4 | 5 | N |
| 21. Calling student by name for input was used effectively. | 1 | 2 | 3 | 4 | 5 | N |
| 22. Students actively participated during the class. | 1 | 2 | 3 | 4 | 5 | N |
| 23. Appropriate pacing was conducted during the class. | 1 | 2 | 3 | 4 | 5 | N |
| 24. Communication between/among sites was not difficult. | 1 | 2 | 3 | 4 | 5 | N |
| 25. Classrooms/sites were organized and managed well. | 1 | 2 | 3 | 4 | 5 | N |

Part III**Attitudes**

| | SD | D | U | A | SA | N |
|---|-----------|----------|----------|----------|-----------|----------|
| 26. My attitude toward the use of ITV technology for teaching and learning is positive. | 1 | 2 | 3 | 4 | 5 | N |
| 27. My attitude toward ITV courses in general is positive. | 1 | 2 | 3 | 4 | 5 | N |
| 28. I felt comfortable with the ITV classes. | 1 | 2 | 3 | 4 | 5 | N |
| 29. I am satisfied with ITV instructions. | 1 | 2 | 3 | 4 | 5 | N |

30. What is one thing that you like best about ITV classes?

31. What is one thing that you dislike most about ITV classes?

32. Are there any comments about ITV classes you would like to add?

Please continue on next page

Part IV
Information

33. Gender:
- Female
 - Male
34. Age:
- Under 26
 - 26~35
 - 36~45
 - 46~55
 - 56~65
 - Over 65
35. Years of teaching in university/college:
- 1~5 years
 - 6~10 years
 - 11~15 years
 - 16~20 years
 - Over 20 years
36. Years of teaching ITV courses:
- Under 1 year
 - 1~2 years
 - 3~4 years
 - 5~6 years
 - Over 6 years
37. How many ITV courses have you taught?
- 1
 - 2
 - 3
 - 4
 - 5 or more
38. Did you attend an ITV workshop or training session before teaching an ITV course?
- Yes
 - No

Please continue on next page

39. What is the number of sites you taught in this course (including origination site)?
- a. 2
 - b. 3
 - c. 4
 - d. 5
 - e. 6
 - f. 7 or more

**Thank you for your assistance in this research project.
Please return your completed questionnaire in the enclosed envelope.**

APPENDIX F

INTERACTIVE TELEVISION (ITV) PROGRAM

STUDENT QUESTIONNAIRE

| In my ITV class | SD | D | U | A | SA | N |
|--|-----------|----------|----------|----------|-----------|----------|
| 16. Reviewing of the previous contents at the beginning of the class was used effectively. | 1 | 2 | 3 | 4 | 5 | N |
| 17. Assignments were clearly presented and discussed during class time. | 1 | 2 | 3 | 4 | 5 | N |
| 18. A variety of teaching methods was used effectively. | 1 | 2 | 3 | 4 | 5 | N |

Part II

Classroom Management

| In my ITV Class | SD | D | U | A | SA | N |
|---|-----------|----------|----------|----------|-----------|----------|
| 19. Instructional materials and/or other handouts were provided in timely manner. | 1 | 2 | 3 | 4 | 5 | N |
| 20. Interaction between sites was frequent. | 1 | 2 | 3 | 4 | 5 | N |
| 21. Calling student by name for input was used effectively. | 1 | 2 | 3 | 4 | 5 | N |
| 22. Students actively participated during the class. | 1 | 2 | 3 | 4 | 5 | N |
| 23. Appropriate pacing was conducted during the class. | 1 | 2 | 3 | 4 | 5 | N |
| 24. Communication between/among sites was not difficult. | 1 | 2 | 3 | 4 | 5 | N |
| 25. Classrooms/sites were organized and managed well. | 1 | 2 | 3 | 4 | 5 | N |

Part III

Attitudes

| | SD | D | U | A | SA | N |
|---|-----------|----------|----------|----------|-----------|----------|
| 26. My attitude toward the use of ITV technology for teaching and learning is positive. | 1 | 2 | 3 | 4 | 5 | N |
| 27. My attitude toward ITV courses in general is positive. | 1 | 2 | 3 | 4 | 5 | N |
| 28. I felt comfortable with the ITV class. | 1 | 2 | 3 | 4 | 5 | N |
| 29. I am satisfied with ITV instruction. | 1 | 2 | 3 | 4 | 5 | N |

30. What is one thing that you like best about ITV classes?

31. What is one thing that you dislike most about ITV classes?

32. Are there any comments about ITV classes you would like to add?

Please continue on next page

Part IV
Information

33. Gender
- Female
 - Male
34. Student Status
- Undergraduate Part-time
 - Undergraduate Full-time
 - Graduate Part-time
 - Graduate Full-time
 - None credit
 - Other _____
35. Age
- 23 or under
 - 24-35
 - 36-45
 - 46-55
 - Over 55
36. How many ITV courses have you taken?
- 1
 - 2
 - 3
 - 4
 - 5 or more

Thank you for your assistance in this research project.
Please return your completed questionnaire in the enclosed envelope.

APPENDIX G

NOTE FOR RECEIVING

A SUMMARY OF STUDT RESULTS

Note

If you are interested in the summary of the results of this study, please fill in the lines below and return it with the questionnaire. Thank you!

Your E-mail: _____

Or Name: _____

Address: _____

APPENDIX H

(CHINESE VERSION)

REQUEST NKNU ITV PROGRAM
TEACHERS AND STUDENTS
FOR PARTICIPATING RESEARCH

懇請參與研究 邀請函

敬愛的教授/同學 您好：

敬仰 您對遠距教學/學習 經驗豐富，懇請參與本人之研究，並請不吝指教為感。

此研究論文題目是：「使用互動式即時群播科技之特定大學當前遠距教學情形之分析研究」。問卷調查的目的在於收集資料，以便對台灣南區互動式即時群播之教學與美國北愛荷華大學互動式即時群播之教學作比較。您的回答，對此研究非常重要，懇請於3月21日前，能填妥問卷，並請撥空寄回。謝謝您！

本問卷採匿名方式，且在統計工作完成後全部銷毀。回函信封上有一號碼，作為核對名單之用，當問卷已回收，就不再追請寄回。

若 您對該研究之結果有興趣，請填寫隨附之表格，並請隨問卷 寄回。摘要將於八月中旬奉上寄達。如果 您有任何問題或建議，敬請來電：(07) 723-1393 或 E-mail: rsmchang@nknucc.nknu.edu.tw 謝謝您！

敬頌 春祺

萬事如意

美國 北愛荷華大學 研究生：張勝茂 指導教授：Dr. John T. Fecik
敬上
中華民國 八十九年三月六日

APPENDIX I

(CHINESE VERSION)

INTERACTIVE TELEVISION (ITV) PROGRAM

TEACHER QUESTIONNAIRE

互動式即時群播(Interactive Television)遠距教學 教師組 問卷

非常感謝您花時間幫忙。這份問卷題沒有對與錯之答案，請輕鬆作答，並請圈選出最符合您感覺與情況之數字或字母。每題請選一個答案即可。

01. 請寫出,您曾教過的互動式即時群播教學之科目名稱?(請寫出一科即可)

| 第一部份：教學法 | 非常 不同 同意 | 不 同 意 | 未 決 定 | 同 意 | 非 常 同 意 | 沒 不 使 適 用 |
|--|----------------|-------------|-------------|--------|------------------|-----------------------|
| 在互動式即時群播教學的班級 | | | | | | |
| 02. 在教課之初,即明確講解課程目標. | 1 | 2 | 3 | 4 | 5 | N |
| 03. 有效運用 視覺輔助教具(例如,圖片、照片、模型、地圖、或者圖表其非從Power Point 而來). | 1 | 2 | 3 | 4 | 5 | N |
| 04. 有效運用 質問技巧(Questioning Techniques). | 1 | 2 | 3 | 4 | 5 | N |
| 05. 有效運用 總結技巧(Summarizing Techniques). | 1 | 2 | 3 | 4 | 5 | N |
| 06. 有效運用 文件攝影機(頂上攝影機). | 1 | 2 | 3 | 4 | 5 | N |
| 07. 有效運用 全球資訊網(World Wide Web). | 1 | 2 | 3 | 4 | 5 | N |
| 08. 有效運用 教學軟體(例如, Power Point). | 1 | 2 | 3 | 4 | 5 | N |
| 09. 有效運用 測驗,考試,或其它考評方法. | 1 | 2 | 3 | 4 | 5 | N |
| 10. 有效運用 解決問題的模擬教學法或者個案研習法. | 1 | 2 | 3 | 4 | 5 | N |
| 11. 有效運用 小組討論法. | 1 | 2 | 3 | 4 | 5 | N |
| 12. 有效運用 演講教學法. | 1 | 2 | 3 | 4 | 5 | N |
| 13. 有效運用 示範教學法. | 1 | 2 | 3 | 4 | 5 | N |
| 14. 有組織的講述課程教材. | 1 | 2 | 3 | 4 | 5 | N |
| 15. 有效運用 "互動式學習指引(ISG)". | 1 | 2 | 3 | 4 | 5 | N |
| 16. 課堂開始時,有效運用 複習先前已教之內容. | 1 | 2 | 3 | 4 | 5 | N |
| 17. 在課堂上,清楚的講述及討論習題作業. | 1 | 2 | 3 | 4 | 5 | N |
| 18. 有效運用 多樣式混合的教學方法. | 1 | 2 | 3 | 4 | 5 | N |
| 第二部份：班級經營 | | | | | | |
| 在互動式即時群播教學的班級 | | | | | | |
| 19. 教學教材或教學資料均適時的提供給學生. | 1 | 2 | 3 | 4 | 5 | N |
| 20. 各端(收播端與主播端或收播端)間的互動頻繁. | 1 | 2 | 3 | 4 | 5 | N |
| 21. 有效運用 點叫學生名字,以便回答問題. | 1 | 2 | 3 | 4 | 5 | N |
| 22. 上課時,學生主動參與教學. | 1 | 2 | 3 | 4 | 5 | N |

請繼續作答下一頁

| | 非常不同意 | 不同意 | 未決定 | 同意 | 非常同意 | 沒不適用 |
|-------------------------------|-------|-----|-----|----|------|------|
| 在互動式即時群播教學的班級 | | | | | | |
| 23. 上課時,進行著恰當的教學步調,不會太快亦不會太慢. | 1 | 2 | 3 | 4 | 5 | N |
| 24. 端與端(收播端與主播端或收播端)間的溝通沒有困難. | 1 | 2 | 3 | 4 | 5 | N |
| 25. 該班級有組織且經營良好. | 1 | 2 | 3 | 4 | 5 | N |

| | 非常不同意 | 不同意 | 未決定 | 同意 | 非常同意 | 沒不適用 |
|---|-------|-----|-----|----|------|------|
| 第三部份：態度 | | | | | | |
| 26. 我對 使用互動式即時群播之科技來教學 的態度是正面的. | 1 | 2 | 3 | 4 | 5 | N |
| 27. 我對 互動式即時群播教學之課程 的態度是正面的. | 1 | 2 | 3 | 4 | 5 | N |
| 28. 在互動式即時群播教學之班級上課,我覺得自在. | 1 | 2 | 3 | 4 | 5 | N |
| 29. 我滿意這種互動式即時群播之教學. | 1 | 2 | 3 | 4 | 5 | N |
| 30. 對於互動式即時群播教學之班級,您最喜歡的一件事是什麼? _____ | | | | | | |
| 31. 對於互動式即時群播教學之班級,您最不喜歡的一件事是什麼? _____ | | | | | | |
| 32. 對於互動式即時群播教學之班級,您有其它的意見嗎? _____ | | | | | | |

第四部份：基本資料

33. 性別
- 女
 - 男

請繼續作答下一頁

34. 年齡
- a. 26 歲以下
 - b. 26~35 歲
 - c. 36~45 歲
 - d. 46~55 歲
 - e. 56~65 歲
 - f. 65 歲以上
35. 您任職大學/學院年資 共有幾年?
- a. 1~5 年
 - b. 6~10 年
 - c. 11~15 年
 - d. 16~20 年
 - e. 超過 20 年
36. 您任教 互動式即時群播教學課程 共有幾年?
- a. 1 年以下
 - b. 1~2 年
 - c. 3~4 年
 - d. 5~6 年
 - e. 超過 6 年
37. 您教過 幾科 互動式即時群播教學之課程?
- a. 1
 - b. 2
 - c. 3
 - d. 4
 - e. 5 或 更多
38. 教課前, 您曾參加過 互動式即時群播教學 之研討會或訓練課程嗎?
- a. 有
 - b. 沒有
39. 您教的 互動式即時群播課程 共有幾個端點(包括主播端及收播端)?
- a. 2
 - b. 3
 - c. 4
 - d. 5
 - e. 6
 - f. 7 或更多

懇請寄回本問卷。 再次謝謝您!

APPENDIX J

(CHINESE VERSION)

INTERACTIVE TELEVISION (ITV) PROGRAM

STUDENT QUESTIONNAIRE

互動式即時群播(Interactive Television)遠距教學 學生組 問卷

非常感謝您幫忙。這份問卷題沒有對與錯之答案，請輕鬆作答，並請圈選出最符合您感覺與情況之數字或字母。每題請選一個答案即可。

01. 請寫出,您在互動式即時群播教學之收播端,選修過的科目名稱?
(請寫出一科即可)

| 第一部份：教學法 | 非 常 不 同 意 | 不 同 意 | 未 決 定 | 同 意 | 非 常 同 意 | 沒 不 使 用 |
|--|-----------------------|-------------|-------------|--------|------------------|------------------|
| 在互動式即時群播教學的班級 | | | | | | |
| 02. 在教課之初,即明確講解課程目標. | 1 | 2 | 3 | 4 | 5 | N |
| 03. 有效運用 視覺輔助教具(例如,圖片、照片、模型、地圖、或者圖表其非從Power Point 而來). | 1 | 2 | 3 | 4 | 5 | N |
| 04. 有效運用 質問技巧(Questioning Techniques). | 1 | 2 | 3 | 4 | 5 | N |
| 05. 有效運用 總結技巧(Summarizing Techniques). | 1 | 2 | 3 | 4 | 5 | N |
| 06. 有效運用 文件攝影機(頂上攝影機). | 1 | 2 | 3 | 4 | 5 | N |
| 07. 有效運用 全球資訊網(World Wide Web). | 1 | 2 | 3 | 4 | 5 | N |
| 08. 有效運用 教學軟體(例如, Power Point). | 1 | 2 | 3 | 4 | 5 | N |
| 09. 有效運用 測驗,考試,或其它考評方法. | 1 | 2 | 3 | 4 | 5 | N |
| 10. 有效運用 解決問題的模擬教學法或者個案研習法. | 1 | 2 | 3 | 4 | 5 | N |
| 11. 有效運用 小組討論法. | 1 | 2 | 3 | 4 | 5 | N |
| 12. 有效運用 演講教學法. | 1 | 2 | 3 | 4 | 5 | N |
| 13. 有效運用 示範教學法. | 1 | 2 | 3 | 4 | 5 | N |
| 14. 有組織的講述課程教材. | 1 | 2 | 3 | 4 | 5 | N |
| 15. 有效運用 "互動式學習指引(ISG)". | 1 | 2 | 3 | 4 | 5 | N |
| 16. 課堂開始時,有效運用 複習先前已教之內容. | 1 | 2 | 3 | 4 | 5 | N |
| 17. 在課堂上,清楚的講述及討論習題作業. | 1 | 2 | 3 | 4 | 5 | N |
| 18. 有效運用 多樣式混合的教學方法. | 1 | 2 | 3 | 4 | 5 | N |
| 第二部份：班級經營 | | | | | | |
| 在互動式即時群播教學的班級 | | | | | | |
| 19. 教學教材或教學資料均適時的提供給學生. | 1 | 2 | 3 | 4 | 5 | N |
| 20. 各端(收播端與主播端或收播端)間的互動頻繁. | 1 | 2 | 3 | 4 | 5 | N |
| 21. 有效運用 點叫學生名字,以便回答問題. | 1 | 2 | 3 | 4 | 5 | N |
| 22. 上課時,學生主動參與教學. | 1 | 2 | 3 | 4 | 5 | N |

請繼續作答下一頁

| 在互動式即時群播教學的班級 | 非常不同意 | 不同意 | 未決定 | 同意 | 非常同意 | 沒不適用 |
|-------------------------------|-------|-----|-----|----|------|------|
| 23. 上課時,進行著恰當的教學步調,不會太快亦不會太慢. | 1 | 2 | 3 | 4 | 5 | N |
| 24. 端與端(收播端與主播端或收播端)間的溝通沒有困難. | 1 | 2 | 3 | 4 | 5 | N |
| 25. 該班級有組織且經營良好. | 1 | 2 | 3 | 4 | 5 | N |

| 第三部份：態度 | 非常不同意 | 不同意 | 未決定 | 同意 | 非常同意 | 沒不適用 |
|---|-------|-----|-----|----|------|------|
| 26. 我對 使用互動式即時群播之科技來教學 的態度是正面的. | 1 | 2 | 3 | 4 | 5 | N |
| 27. 我對 互動式即時群播教學之課程 的態度是正面的. | 1 | 2 | 3 | 4 | 5 | N |
| 28. 在互動式即時群播教學之班級上課,我覺得自在. | 1 | 2 | 3 | 4 | 5 | N |
| 29. 我滿意這種互動式即時群播之教學. | 1 | 2 | 3 | 4 | 5 | N |
| 30. 對於互動式即時群播教學之班級,您最喜歡的一件事是什麼? _____ | | | | | | |
| 31. 對於互動式即時群播教學之班級,您最不喜歡的一件事是什麼? _____ | | | | | | |
| 32. 對於互動式即時群播教學之班級,您有其它的意見嗎? _____ | | | | | | |

第四部份：基本資料

33. 性別
- 女
 - 男

請繼續作答下一頁

34. 學生狀況

- a. 學士班 選讀生
- b. 學士班 全修生
- c. 碩士班 選讀生
- d. 碩士班 全修生
- e. 無學分班
- F. 其它

35. 年齡

- a. 23歲 或以下
- b. 24~35歲
- c. 36~45歲
- d. 46~55歲
- e. 55歲以上

36. 您總共選修過 幾科 互動式即時群播教學之課程?

- a. 1 科
- b. 2 科
- c. 3 科
- d. 4 科
- e. 5 科 或更多

懇請寄回本問卷，再次謝謝您！

APPENDIX K

(CHINESE VERSION)

NOTE FOR RECEIVING

A SUMMARY OF STUDY RESULTS

索取摘要 表

若 您對該研究之結果有興趣，煩請填妥下列表格，並請隨同問卷寄回。 謝謝您!

您的 E-mail: _____

或者 姓名: _____

通訊處: _____

APPENDIX L

DESCRIPTIVE AND INFERENTIAL STATISTICAL DATA
OF EACH QUESTION OF
QUESTIONNAIRE PART I: ITV TEACHING METHODS

Note. Likert scale was used to determine the mean scores. It ranges are: SD (Strongly Disagree) = 1, D (Disagree) = 2, U (Undecided) = 3, A (Agree) = 4, SA (Strongly Agree) = 5.

NU = Not Used. (This value in "NU" is the same as in "N" on questionnaire)

n = Valid Frequency.

School Factors are UNI and NKNU.

Member Factors are Teachers and Students.

It is unnecessary to compare the items which "NU" percentages are under 5% in both schools.

Questionnaire Item 02: Objectives of the Course Were Identified Clearly at the Beginning

| | Frequency and Percentage | | | | | | <u>M</u> | <u>SD</u> | <u>n</u> |
|---------------|--------------------------|------------|-----------|--------------|-------------|-----------|----------|-----------|----------|
| | <u>SD</u> | <u>D</u> | <u>U</u> | <u>A</u> | <u>SA</u> | <u>NU</u> | | | |
| UNI Teachers | 0 | 0 | 3 9.4% | 10 31.3% | 19 59.4% | 0 | 4.50 | 0.67 | 32 |
| UNI Students | 1 0.6% | 12 7.6% | 9 5.7% | 64 40.8% | 70 44.6% | 1 0.6% | 4.22 | 0.91 | 156 |
| UNI | | | | | | 1 1.1% | | | 189 |
| NKNU Teachers | 0 | 1 3.3% | 0 | 8 26.7% | 21 70.0% | 0 | 4.63 | 0.67 | 30 |
| NKNU Students | 0 | 2 1.1% | 9 5.1% | 110 61.8% | 57 32% | 0 | 4.25 | 0.60 | 178 |
| NKNU | | | | | | 0 | | | 208 |

Two-Way ANOVA Summary Table

| Source | <u>df</u> | <u>MS</u> | <u>F</u> | <u>p</u> |
|-----------------|-----------|-----------|----------|----------|
| School Factor | 1 | 0.35 | 0.62 | 0.43 |
| Member Factor | 1 | 5.83 | 10.45 | 0.01* |
| School x Member | 1 | 0.14 | 0.25 | 0.62 |
| Error | 392 | 0.56 | | |
| Total | 396 | | | |

Questionnaire Item 03: Visual Teaching Aids Were Effectively Used to Explain Concepts

| | Frequency and Percentage | | | | | | <u>M</u> | <u>SD</u> | <u>n</u> |
|---------------|--------------------------|-------------|------------|-------------|-------------|-------------|----------|-----------|----------|
| | SD | D | U | A | SA | NU | | | |
| UNI Teachers | 1 3.1% | 1 3.1% | 4 12.5% | 12 37.5% | 14 43.8% | 0 | 4.16 | 0.99 | 32 |
| UNI Students | 7 4.5% | 28 17.8% | 9 5.7% | 78 49.7% | 30 19.1% | 5 3.2% | 3.63 | 1.13 | 152 |
| UNI | | | | | | 5 2.6% | | | 189 |
| NKNU Teachers | 0 | 1 3.3% | 0 | 17 56.7% | 12 40.0% | 0 | 4.33 | 0.66 | 30 |
| NKNU Students | 3 1.7% | 24 13.5% | 12 6.7% | 96 53.9% | 24 13.5% | 19 10.7% | 3.72 | 0.96 | 159 |
| NKNU | | | | | | 19 9.0% | | | 208 |

Two-Way ANOVA Summary Table

| Source | <u>df</u> | <u>MS</u> | <u>F</u> | <u>p</u> |
|-----------------|-----------|-----------|----------|----------|
| School Factor | 1 | 0.89 | 0.86 | 0.36 |
| Member Factor | 1 | 16.81 | 16.22 | 0.01* |
| School x Member | 1 | 0.11 | 0.11 | 0.75 |
| Error | 369 | 1.04 | | |
| Total | 373 | | | |

Chi-Square Summary Figure

| | UNI | NKNU | |
|----------|-----|------|---------------------------|
| Not Used | 5 | 19 | $\chi^2 = 7.34$ |
| Used | 184 | 189 | $\chi^2_{.95 (1)} = 3.84$ |

Questionnaire Item 04: Questioning Techniques Were Used Effectively

| | Frequency and Percentage | | | | | | <u>M</u> | <u>SD</u> | <u>n</u> |
|---------------|--------------------------|-------------|-------------|-------------|-------------|-----------|----------|-----------|----------|
| | SD | D | U | A | SA | NU | | | |
| UNI Teachers | 0 | 0 | 2 6.3% | 21 65.6% | 9 28.1% | 0 | 4.22 | 0.55 | 32 |
| UNI Students | 2 1.3% | 12 7.7% | 14 9.0% | 97 62.6% | 29 18.7% | 1 0.6% | 3.90 | 0.84 | 154 |
| UNI | | | | | | 1 1.1% | | | 187 |
| NKNU Teachers | 1 3.3% | 5 16.7% | 1 3.3% | 12 40.0% | 10 33.3% | 1 3.3% | 3.86 | 1.19 | 29 |
| NKNU Students | 2 1.1% | 29 16.5% | 26 14.8% | 98 55.7% | 16 9.1% | 5 2.8% | 3.57 | 0.92 | 171 |
| NKNU | | | | | | 6 3.4% | | | 206 |

Note. UNI students had 2 missing cases.
NKNU students had 2 missing cases.

Two-Way ANOVA Summary Table

| Source | <u>df</u> | <u>MS</u> | <u>F</u> | <u>p</u> |
|-----------------|-----------|-----------|----------|----------|
| School Factor | 1 | 6.13 | 7.80 | 0.01* |
| Member Factor | 1 | 4.78 | 6.08 | 0.02* |
| School x Member | 1 | 0.00 | 0.01 | 0.93 |
| Error | 382 | 0.79 | | |
| Total | 386 | | | |

Questionnaire Item 05: Summarizing Techniques Were Used Effectively

| | Frequency and Percentage | | | | | | <u>M</u> | <u>SD</u> | <u>n</u> |
|---------------|--------------------------|------------|-------------|--------------|-------------|-----------|----------|-----------|----------|
| | <u>SD</u> | <u>D</u> | <u>U</u> | <u>A</u> | <u>SA</u> | <u>NU</u> | | | |
| UNI Teachers | 1 3.1% | 0 | 2 6.3% | 19 59.4% | 10 31.3% | 0 | 4.16 | 0.81 | 32 |
| UNI Students | 3 1.9% | 12 7.6% | 18 11.5% | 94 59.9% | 30 19.1% | 0 | 3.87 | 0.88 | 157 |
| UNI | | | | | | 0 | | | 189 |
| NKNU Teachers | 0 | 2 6.7% | 2 6.7% | 13 43.3% | 12 40.0% | 1 3.3% | 4.21 | 0.86 | 29 |
| NKNU Students | 0 | 13 7.3% | 34 19.2% | 102 57.6% | 22 12.4% | 6 3.4% | 3.78 | 0.77 | 171 |
| NKNU | | | | | | 7 3.4% | | | 207 |

Note. NKNU students had 1 missing case.

Two-Way ANOVA Summary Table

| <u>Source</u> | <u>df</u> | <u>MS</u> | <u>F</u> | <u>p</u> |
|-----------------|-----------|-----------|----------|----------|
| School Factor | 1 | 0.02 | 0.03 | 0.87 |
| Member Factor | 1 | 6.63 | 9.80 | 0.01* |
| School x Member | 1 | 0.25 | 0.37 | 0.55 |
| Error | 385 | 0.68 | | |
| Total | 389 | | | |

Questionnaire Item 06: The Overhead Camera (Document Camera) Was Used Effectively

| | Frequency and Percentage | | | | | | <u>M</u> | <u>SD</u> | <u>n</u> |
|---------------|--------------------------|-------------|-------------|-------------|-------------|------------|----------|-----------|----------|
| | SD | D | U | A | SA | NU | | | |
| UNI Teachers | 0 | 2 6.3% | 1 3.1% | 10 31.3% | 19 59.4% | 0 | 4.44 | 0.84 | 32 |
| UNI Students | 2 1.3% | 15 9.6% | 13 8.3% | 78 49.7% | 46 29.3% | 3 1.9% | 3.98 | 0.95 | 154 |
| UNI | | | | | | 3 1.6% | | | 189 |
| NKNU Teachers | 0 | 0 | 2 6.7% | 10 33.3% | 14 46.7% | 4 13.3% | 4.46 | 0.65 | 26 |
| NKNU Students | 0 | 19 10.7% | 23 13.0% | 96 54.2% | 35 19.8% | 4 2.3% | 3.85 | 0.87 | 173 |
| NKNU | | | | | | 8 3.9% | | | 207 |

Note. NKNU students had 1 missing case.

Two-Way ANOVA Summary Table

| Source | <u>df</u> | <u>MS</u> | <u>F</u> | <u>p</u> |
|-----------------|-----------|-----------|----------|----------|
| School Factor | 1 | 0.14 | 0.18 | 0.67 |
| Member Factor | 1 | 13.93 | 17.73 | 0.01* |
| School x Member | 1 | 0.29 | 0.37 | 0.54 |
| Error | 381 | 0.79 | | |
| Total | 385 | | | |

Questionnaire Item 07: World Wide Web (WWW) Was Used Effectively

| | Frequency and Percentage | | | | | | <u>M</u> | <u>SD</u> | <u>n</u> |
|---------------|--------------------------|-------------|-------------|-------------|-------------|-------------|----------|-----------|----------|
| | SD | D | U | A | SA | NU | | | |
| UNI Teachers | 2 6.3% | 5 15.6% | 1 3.1% | 7 21.9% | 5 15.6% | 12 37.5% | 3.40 | 1.39 | 20 |
| UNI Students | 10 6.4% | 16 10.3% | 21 13.5% | 28 17.9% | 24 15.4% | 57 36.5% | 3.40 | 1.29 | 99 |
| UNI | | | | | | 69 36.7% | | | 188 |
| NKNU Teachers | 0 | 2 6.7% | 4 13.3% | 7 23.3% | 6 20.0% | 11 36.7% | 3.89 | 0.99 | 19 |
| NKNU Students | 6 3.4% | 39 21.9% | 30 16.9% | 53 29.8% | 23 12.9% | 27 15.2% | 3.32 | 1.13 | 151 |
| NKNU | | | | | | 38 18.3% | | | 208 |

Note. UNI students had 1 missing case.

Two-Way ANOVA Summary Table

| Source | <u>df</u> | <u>MS</u> | <u>F</u> | <u>p</u> |
|-----------------|-----------|-----------|----------|----------|
| School Factor | 1 | 1.40 | 0.97 | 0.33 |
| Member Factor | 1 | 2.75 | 1.91 | 0.17 |
| School x Member | 1 | 2.83 | 1.96 | 0.16 |
| Error | 285 | 1.44 | | |
| Total | 289 | | | |

Chi-Square Summary Figure

| | UNI | NKNU | |
|----------|-----|------|---------------------------|
| Not Used | 69 | 38 | $\chi^2 = 17.01$ |
| Used | 119 | 170 | $\chi^2_{.95 (1)} = 3.84$ |

Questionnaire Item 08: Presentation Software (e.g., Power Point) Programs Were Used Effectively

| | Frequency and Percentage | | | | | | <u>M</u> | <u>SD</u> | <u>n</u> |
|---------------|--------------------------|-------------|-------------|-------------|-------------|-------------|----------|-----------|----------|
| | SD | D | U | A | SA | NU | | | |
| UNI Teachers | 1 3.1% | 4 12.5% | 0 | 7 21.9% | 11 34.4% | 9 28.1% | 4.00 | 1.28 | 23 |
| UNI Students | 7 4.5% | 10 6.4% | 7 4.5% | 56 35.7% | 51 32.5% | 26 16.6% | 4.02 | 1.11 | 131 |
| UNI | | | | | | 35 18.5% | | | 189 |
| NKNU Teachers | 0 | 3 10.0% | 1 3.3% | 11 36.7% | 9 30.0% | 6 20.0% | 4.08 | 0.97 | 24 |
| NKNU Students | 4 2.2% | 31 17.4% | 35 19.7% | 52 29.2% | 22 12.4% | 34 19.1% | 3.40 | 1.07 | 144 |
| NKNU | | | | | | 40 19.2% | | | 208 |

Two-Way ANOVA Summary Table

| Source | <u>df</u> | <u>MS</u> | <u>F</u> | <u>p</u> |
|-----------------|-----------|-----------|----------|----------|
| School Factor | 1 | 2.97 | 2.46 | 0.12 |
| Member Factor | 1 | 4.43 | 3.68 | 0.06 |
| School x Member | 1 | 5.06 | 4.20 | 0.04* |
| Error | 318 | 1.21 | | |
| Total | 322 | | | |

Chi-Square Summary Figure

| | UNI | NKNU | |
|----------|-----|------|---------------------------|
| Not Used | 35 | 40 | $\chi^2 = 0.03$ |
| Used | 154 | 168 | $\chi^2_{.95 (1)} = 3.84$ |

Questionnaire Item 09: Tests, Examinations, or Other Assessments Were Used Effectively

| | Frequency and Percentage | | | | | | <u>M</u> | <u>SD</u> | <u>n</u> |
|---------------|--------------------------|-------------|-------------|-------------|-------------|-------------|----------|-----------|----------|
| | SD | D | U | A | SA | NU | | | |
| UNI Teachers | 1 3.1% | 6 18.8% | 3 9.4% | 9 28.1% | 5 15.6% | 8 25.0% | 3.46 | 1.22 | 24 |
| UNI Students | 7 4.5% | 11 7.1% | 25 15.0% | 61 39.1% | 35 22.4% | 17 10.9% | 3.76 | 1.07 | 139 |
| UNI | | | | | | 25 13.3% | | | 188 |
| NKNU Teachers | 1 3.3% | 2 6.7% | 3 10.0% | 16 53.3% | 5 16.7% | 3 10.0% | 3.81 | 0.96 | 27 |
| NKNU Students | 2 1.1% | 30 16.9% | 35 19.7% | 80 44.9% | 23 12.9% | 8 4.5% | 3.54 | 0.97 | 170 |
| NKNU | | | | | | 11 5.3% | | | 208 |

Note. UNI students had 1 missing case.

Two-Way ANOVA Summary Table

| Source | <u>df</u> | <u>MS</u> | <u>F</u> | <u>p</u> |
|-----------------|-----------|-----------|----------|----------|
| School Factor | 1 | 0.20 | 0.19 | 0.67 |
| Member Factor | 1 | 0.01 | 0.01 | 0.92 |
| School x Member | 1 | 3.64 | 3.43 | 0.07 |
| Error | 356 | 1.06 | | |
| Total | 360 | | | |

Chi-Square Summary Figure

| | UNI | NKNU | |
|----------|-----|------|---------------------------|
| Not Used | 25 | 11 | $\chi^2 = 7.66$ |
| Used | 163 | 197 | $\chi^2_{.95 (1)} = 3.84$ |

Questionnaire Item 10: Problem-Solving Simulations or Case Studies Were Used Effectively

| | Frequency and Percentage | | | | | | <u>M</u> | <u>SD</u> | <u>n</u> |
|---------------|--------------------------|-------------|-------------|-------------|-------------|-------------|----------|-----------|----------|
| | SD | D | U | A | SA | NU | | | |
| UNI Teachers | 0 | 2 6.3% | 4 12.5% | 14 43.8% | 6 18.8% | 6 18.8% | 3.92 | 0.84 | 26 |
| UNI Students | 1 0.6% | 11 7.0% | 21 13.4% | 82 52.2% | 29 18.5% | 13 8.3% | 3.88 | 0.84 | 144 |
| UNI | | | | | | 19 10.1% | | | 189 |
| NKNU Teachers | 0 | 3 10.0% | 8 26.7% | 12 40.0% | 4 13.3% | 3 10.0% | 3.63 | 0.88 | 27 |
| NKNU Students | 3 1.7% | 29 16.3% | 55 30.9% | 54 30.3% | 16 9.0% | 21 11.8% | 3.32 | 0.96 | 157 |
| NKNU | | | | | | 24 11.5% | | | 208 |

Two-Way ANOVA Summary Table

| Source | <u>df</u> | <u>MS</u> | <u>F</u> | <u>p</u> |
|-----------------|-----------|-----------|----------|----------|
| School Factor | 1 | 8.15 | 10.13 | 0.01* |
| Member Factor | 1 | 1.35 | 1.68 | 0.20 |
| School x Member | 1 | 0.78 | 0.97 | 0.33 |
| Error | 350 | 0.80 | | |
| Total | 354 | | | |

Chi-Square Summary Figure

| | UNI | NKNU | |
|----------|-----|------|---------------------------|
| Not Used | 19 | 24 | $\chi^2 = 0.23$ |
| Used | 170 | 184 | $\chi^2_{.95 (1)} = 3.84$ |

Questionnaire Item 11: Small-Group Discussions Were Used Effectively

| | Frequency and Percentage | | | | | | <u>M</u> | <u>SD</u> | <u>n</u> |
|---------------|--------------------------|-------------|-------------|-------------|-------------|-------------|----------|-----------|----------|
| | SD | D | U | A | SA | NU | | | |
| UNI Teachers | 1 3.1% | 1 3.1% | 8 25.0% | 15 46.9% | 6 18.8% | 1 3.1% | 3.77 | 0.92 | 31 |
| UNI Students | 7 4.5% | 19 12.1% | 24 15.3% | 65 41.4% | 38 24.2% | 4 2.5% | 3.71 | 1.11 | 153 |
| UNI | | | | | | 5 2.6% | | | 189 |
| NKNU Teachers | 1 3.3% | 9 30.0% | 4 13.3% | 8 26.7% | 4 13.3% | 4 13.3% | 3.19 | 1.20 | 26 |
| NKNU Students | 15 8.4% | 51 28.7% | 32 18.0% | 41 23.0% | 13 7.3% | 26 14.6% | 2.91 | 1.16 | 152 |
| NKNU | | | | | | 30 14.4% | | | 208 |

Two-Way ANOVA Summary Table

| Source | <u>df</u> | <u>MS</u> | <u>F</u> | <u>p</u> |
|----------------|-----------|-----------|----------|----------|
| School Factor | 1 | 22.71 | 17.99 | 0.01* |
| Member Factor | 1 | 1.48 | 1.18 | 0.28 |
| Schol x Member | 1 | 0.56 | 0.44 | 0.51 |
| Error | 358 | 1.26 | | |
| Total | 362 | | | |

Chi-Square Summary Figure

| | UNI | NKNU | |
|----------|-----|------|-------------------------|
| Not Used | 5 | 30 | $\chi^2 = 17.09$ |
| Used | 184 | 178 | $\chi^2 .95 (1) = 3.84$ |

Questionnaire Item 12: Lecture Were Used Effectively

| | Frequency and Percentage | | | | | | <u>M</u> | <u>SD</u> | <u>n</u> |
|---------------|--------------------------|-------------|-------------|--------------|-------------|------------|----------|-----------|----------|
| | SD | D | U | A | SA | NU | | | |
| UNI Teachers | 0 | 2 6.3% | 2 6.3% | 13 40.6% | 13 40.6% | 2 6.3% | 4.23 | 0.86 | 30 |
| UNI Students | 3 1.9% | 16 10.2% | 13 8.3% | 51 58.0% | 33 21.0% | 1 0.6% | 3.97 | 0.93 | 156 |
| UNI | | | | | | 3 1.6% | | | 189 |
| NKNU Teachers | 0 | 2 6.7% | 2 6.7% | 14 46.7% | 11 36.7% | 1 3.3% | 4.17 | 0.85 | 29 |
| NKNU Students | 1 0.6% | 15 8.4% | 26 14.6% | 104 58.4% | 23 12.9% | 9 5.1% | 3.79 | 0.81 | 169 |
| NKNU | | | | | | 10 4.8% | | | 208 |

Two-Way ANOVA Summary Table

| Source | <u>df</u> | <u>MS</u> | <u>F</u> | <u>p</u> |
|-----------------|-----------|-----------|----------|----------|
| School Factor | 1 | 0.24 | 0.32 | 0.57 |
| Member Factor | 1 | 7.08 | 9.41 | 0.01* |
| School x Member | 1 | 0.00 | 0.01 | 0.94 |
| Error | 380 | 0.75 | | |
| Total | 384 | | | |

Questionnaire Item 13: Demonstrations Were Used Effectively

| | Frequency and Percentage | | | | | | <u>M</u> | <u>SD</u> | <u>n</u> |
|---------------|--------------------------|-------|-------|-------|-------|-------|----------|-----------|----------|
| | SD | D | U | A | SA | NU | | | |
| UNI Teachers | 0 | 1 | 5 | 14 | 6 | 6 | 3.96 | 0.77 | 26 |
| | | 3.1% | 15.6% | 43.8% | 18.8% | 18.8% | | | |
| UNI Students | 3 | 19 | 14 | 32 | 23 | 16 | 3.73 | 0.96 | 141 |
| | 1.9% | 12.1% | 8.9% | 52.2% | 14.6% | 10.2% | | | |
| UNI | | | | | | 22 | | | 189 |
| | | | | | | 11.6% | | | |
| NKNU Teachers | 0 | 2 | 4 | 13 | 7 | 4 | 3.96 | 0.87 | 26 |
| | | 6.7% | 13.3% | 43.3% | 23.3% | 13.3% | | | |
| NKNU Students | 1 | 24 | 36 | 87 | 10 | 19 | 3.51 | 0.85 | 158 |
| | 0.6% | 13.6% | 20.3% | 49.2% | 5.6% | 10.7% | | | |
| NKNU | | | | | | 23 | | | 207 |
| | | | | | | 11.1% | | | |

Note. NKNU students had 1 missing case.

Two-Way ANOVA Summary Table

| Source | <u>df</u> | <u>MS</u> | <u>F</u> | <u>p</u> |
|-----------------|-----------|-----------|----------|----------|
| School Factor | 1 | 0.53 | 0.66 | 0.42 |
| Member Factor | 1 | 5.12 | 6.41 | 0.02* |
| School x Member | 1 | 0.53 | 0.66 | 0.42 |
| Error | 347 | 0.80 | | |
| Total | 351 | | | |

Chi-Square Summary Figure

| | UNI | NKNU | |
|----------|-----|------|---------------------------|
| Not Used | 22 | 23 | $\chi^2 = 0.03$ |
| Used | 167 | 184 | $\chi^2_{.95 (1)} = 3.84$ |

Questionnaire Item 14: Course Materials Were Presented in an Organized Way

| | Frequency and Percentage | | | | | | <u>M</u> | <u>SD</u> | <u>n</u> |
|---------------|--------------------------|------------|------------|--------------|-------------|-----------|----------|-----------|----------|
| | <u>SD</u> | <u>D</u> | <u>U</u> | <u>A</u> | <u>SA</u> | <u>NU</u> | | | |
| UNI Teachers | 0 | 0 | 2 6.3% | 15 46.9% | 15 46.9% | 0 | 4.41 | 0.61 | 32 |
| UNI Students | 3 1.9% | 12 7.6% | 10 6.4% | 84 53.5% | 48 30.6% | 0 | 4.03 | 0.92 | 157 |
| UNI | | | | | | 0 | | | 189 |
| NKNU Teachers | 0 | 0 | 0 | 13 43.3% | 17 56.7% | 0 | 4.57 | 0.50 | 30 |
| NKNU Students | 1 0.6% | 7 3.9% | 16 9.0% | 108 60.7% | 45 25.3% | 1 0.6% | 4.07 | 0.74 | 177 |
| NKNU | | | | | | 1 0.5% | | | 208 |

Two-Way ANOVA Summary Table

| Source | <u>df</u> | <u>MS</u> | <u>F</u> | <u>p</u> |
|-----------------|-----------|-----------|----------|----------|
| School Factor | 1 | 0.50 | 0.79 | 0.37 |
| Member Factor | 1 | 9.96 | 15.67 | 0.01* |
| School x Member | 1 | 0.20 | 0.32 | 0.57 |
| Error | 392 | 0.64 | | |
| Total | 396 | | | |

Questionnaire Item 15: Interactive Study Guides (ISG) Were Used Effectively

| | Frequency and Percentage | | | | | | <u>M</u> | <u>SD</u> | <u>n</u> |
|---------------|--------------------------|-------------|-------------|-------------|------------|-------------|----------|-----------|----------|
| | SD | D | U | A | SA | NU | | | |
| UNI Teachers | 2 6.3% | 3 9.4% | 0 | 7 21.9% | 2 6.3% | 18 56.3% | 3.29 | 1.38 | 14 |
| UNI Students | 3 1.9% | 18 11.5% | 20 12.7% | 26 16.6% | 12 7.6% | 78 49.7% | 3.33 | 1.11 | 79 |
| UNI | | | | | | 96 50.8% | | | 189 |
| NKNU Teachers | 0 | 2 6.7% | 2 6.7% | 10 33.3% | 9 30.0% | 7 23.3% | 4.13 | 0.92 | 23 |
| NKNU Students | 1 0.6% | 34 19.1% | 54 30.3% | 49 27.5% | 13 7.3% | 27 15.2% | 3.26 | 0.93 | 151 |
| NKNU | | | | | | 34 16.3% | | | 208 |

Two-Way ANOVA Summary Table

| Source | df | MS | F | p |
|-----------------|-----|------|------|-------|
| School Factor | 1 | 4.46 | 4.84 | 0.06 |
| Member Factor | 1 | 5.12 | 5.03 | 0.03* |
| School x Member | 1 | 6.25 | 6.13 | 0.02* |
| Error | 263 | 1.02 | | |
| Total | 267 | | | |

Chi-Square Summary Figure

| | UNI | NKNU | |
|----------|-----|------|-------------------------|
| Not Used | 96 | 34 | $\chi^2 = 53.36$ |
| Used | 93 | 174 | $\chi^2 .95 (1) = 3.84$ |

Questionnaire Item 16: Reviewing of the Previous Contents at the Beginning of the Class Was Used Effectively

| | Frequency and Percentage | | | | | | <u>M</u> | <u>SD</u> | <u>n</u> |
|---------------|--------------------------|-------------|-------------|-------------|-------------|------------|----------|-----------|----------|
| | SD | D | U | A | SA | NU | | | |
| UNI Teachers | 0 | 1 3.1% | 4 12.5% | 18 56.3% | 6 18.8% | 3 9.4% | 4.00 | 0.71 | 29 |
| UNI Students | 2 1.3% | 26 16.6% | 32 20.4% | 73 46.5% | 16 10.2% | 8 5.1% | 3.50 | 0.95 | 149 |
| UNI | | | | | | 11 5.8% | | | 189 |
| NKNU Teachers | 0 | 1 3.3% | 5 16.7% | 13 43.3% | 7 23.3% | 4 13.3% | 4.00 | 0.80 | 26 |
| NKNU Students | 7 3.9% | 42 23.6% | 49 27.5% | 65 36.5% | 6 3.4% | 9 5.1% | 3.12 | 0.96 | 169 |
| NKNU | | | | | | 13 6.3% | | | 208 |

Two-Way ANOVA Summary Table

| Source | <u>df</u> | <u>MS</u> | <u>F</u> | <u>p</u> |
|-----------------|-----------|-----------|----------|----------|
| School Factor | 1 | 1.68 | 1.94 | 0.17 |
| Member Factor | 1 | 22.01 | 25.44 | 0.01* |
| School x Member | 1 | 1.68 | 1.94 | 0.17 |
| Error | 369 | 0.87 | | |
| Total | 373 | | | |

Chi-Square Summary Figure

| | UNI | NKNU | |
|----------|-----|------|-------------------------|
| Not Used | 11 | 13 | $\chi^2 = 0.03$ |
| Used | 178 | 195 | $\chi^2 .95 (1) = 3.84$ |

Questionnaire Item 17: Assignments Were Clearly Presented and Discussed During Class Time

| | Frequency and Percentage | | | | | | <u>M</u> | <u>SD</u> | <u>n</u> |
|---------------|--------------------------|-------------|-------------|-------------|-------------|------------|----------|-----------|----------|
| | SD | D | U | A | SA | NU | | | |
| UNI Teachers | 0 | 3 9.4% | 1 3.1% | 19 59.4% | 9 28.1% | 0 | 4.06 | 0.84 | 32 |
| UNI Students | 4 2.5% | 18 11.5% | 14 8.9% | 78 49.7% | 42 26.8% | 1 0.6% | 3.87 | 1.02 | 156 |
| UNI | | | | | | 1 2.6% | | | 189 |
| NKNU Teachers | 0 | 1 3.3% | 3 10.0% | 15 50.0% | 9 30.0% | 2 6.7% | 4.14 | 0.76 | 28 |
| NKNU Students | 4 2.3% | 32 18.1% | 32 18.1% | 90 50.8% | 11 6.2% | 8 4.5% | 3.43 | 0.95 | 169 |
| NKNU | | | | | | 10 4.8% | | | 207 |

Note. NKNU students had 1 missing case.

Two-Way ANOVA Summary Table

| Source | <u>df</u> | <u>MS</u> | <u>F</u> | <u>p</u> |
|-----------------|-----------|-----------|----------|----------|
| School Factor | 1 | 1.68 | 1.83 | 0.18 |
| Member Factor | 1 | 10.39 | 11.31 | 0.01* |
| School x Member | 1 | 3.49 | 3.80 | 0.06 |
| Error | 381 | 0.92 | | |
| Total | 385 | | | |

Questionnaire Item 18: A Variety of Teaching Methods Was Used Effectively

| | Frequency and Percentage | | | | | | <u>M</u> | <u>SD</u> | <u>n</u> |
|---------------|--------------------------|-------------|-------------|-------------|-------------|------------|----------|-----------|----------|
| | SD | D | U | A | SA | NU | | | |
| UNI Teachers | 1 3.1% | 3 9.4% | 5 15.6% | 15 46.9% | 8 25.9% | 0 | 3.81 | 1.03 | 32 |
| UNI Students | 7 4.5% | 30 19.1% | 26 16.6% | 67 42.7% | 25 15.9% | 2 1.3% | 3.47 | 1.11 | 155 |
| UNI | | | | | | 2 1.0% | | | 189 |
| NKNU Teachers | 0 | 3 10.0% | 2 6.7% | 13 43.3% | 8 26.7% | 4 13.3% | 4.00 | 0.94 | 26 |
| NKNU Students | 1 0.6% | 37 20.8% | 36 20.2% | 70 39.3% | 18 10.1% | 16 9.0% | 3.41 | 0.98 | 162 |
| NKNU | | | | | | 20 9.6% | | | 208 |

Two-Way ANOVA Summary Table

| Source | <u>df</u> | <u>MS</u> | <u>F</u> | <u>p</u> |
|-----------------|-----------|-----------|----------|----------|
| School Factor | 1 | 0.21 | 0.19 | 0.66 |
| Member Factor | 1 | 10.46 | 9.68 | 0.01* |
| School x Member | 1 | 0.73 | 0.67 | 0.41 |
| Error | 371 | 1.08 | | |
| Total | 375 | | | |

Chi-Square Summary Figure

| | UNI | NKNU | |
|----------|-----|------|---------------------------|
| Not Used | 2 | 20 | $\chi^2 = 13.86$ |
| Used | 187 | 188 | $\chi^2_{.95 (1)} = 3.84$ |

APPENDIX M

DESCRIPTIVE AND INFERENTIAL STATISTICAL DATA
OF EACH QUESTION OF
QUESTIONNAIRE PART II: ITV CLASSROOM MANAGEMENT

Note. Likert scale was used to determine the mean scores. It ranges are: SD (Strongly Disagree) = 1, D (Disagree) = 2, U (Undecided) = 3, A (Agree) = 4, SA (Strongly Agree) = 5.

NA = Not Applicable. (This value in "NA" is the same as in "N" on questionnaire)

n = Valid Frequency.

School Factors are UNI and NKNU.

Member Factors are Teachers and Students.

It is unnecessary to compare the items which "NA" percentages are under 5% in both schools.

Questionnaire Item 19: Instructional Materials and/or Other Handouts Were Provided in Timely Manner

| | Frequency and Percentage | | | | | | <u>M</u> | <u>SD</u> | <u>n</u> |
|---------------|--------------------------|-------------|------------|-------------|-------------|-----------|----------|-----------|----------|
| | SD | D | U | A | SA | NA | | | |
| UNI Teachers | 0 | 3 9.4% | 2 6.3% | 17 53.1% | 9 28.1% | 1 3.1% | 4.03 | 0.87 | 31 |
| UNI Students | 2 1.3% | 29 18.5% | 13 8.3% | 70 44.6% | 43 27.4% | 0 | 3.78 | 1.08 | 157 |
| NKNU Teachers | 0 | 4 13.3% | 2 6.7% | 10 33.3% | 14 46.7% | 0 | 4.13 | 1.04 | 30 |
| NKNU Students | 3 1.7% | 30 16.9% | 16 9.0% | 87 48.9% | 39 21.9% | 3 1.7% | 3.74 | 1.04 | 175 |

Two-Way ANOVA Summary Table

| Source | <u>df</u> | <u>MS</u> | <u>F</u> | <u>p</u> |
|-----------------|-----------|-----------|----------|----------|
| School Factor | 1 | 0.04 | 0.04 | 0.85 |
| Member Factor | 1 | 5.37 | 4.88 | 0.03* |
| School x Member | 1 | 0.28 | 0.26 | 0.61 |
| Error | 389 | 1.10 | | |
| Total | 393 | | | |

Questionnaire Item 20: Interaction Between Sites Was Frequent

| | Frequency and Percentage | | | | | | <u>M</u> | <u>SD</u> | <u>n</u> |
|---------------|--------------------------|-------------|-------------|-------------|-------------|-----------|----------|-----------|----------|
| | SD | D | U | A | SA | NA | | | |
| UNI Teachers | 3 9.4% | 3 9.4% | 6 18.8% | 9 28.1% | 10 31.3% | 1 3.1% | 3.65 | 1.31 | 31 |
| UNI Students | 5 3.2% | 22 14.0% | 12 7.6% | 81 51.6% | 35 22.3% | 2 1.3% | 3.77 | 1.06 | 155 |
| NKNU Teachers | 2 6.7% | 4 13.3% | 2 6.7% | 10 33.3% | 11 36.7% | 1 3.3% | 3.83 | 1.28 | 29 |
| NKNU Students | 6 3.4% | 34 19.2% | 36 20.3% | 83 46.9% | 17 9.6% | 1 0.6% | 3.40 | 1.02 | 176 |

Note. NKNU students had 1 missing case.

Two-Way ANOVA Summary Table

| Source | <u>df</u> | <u>MS</u> | <u>F</u> | <u>p</u> |
|-----------------|-----------|-----------|----------|----------|
| School Factor | 1 | 0.42 | 0.36 | 0.55 |
| Member Factor | 1 | 1.15 | 0.99 | 0.32 |
| School x Member | 1 | 3.79 | 3.27 | 0.07 |
| Error | 387 | 1.16 | | |
| Total | 391 | | | |

Questionnaire Item 21: Calling Student by name for Input Was Used Effectively

| | Frequency and Percentage | | | | | | <u>M</u> | <u>SD</u> | <u>n</u> |
|---------------|--------------------------|-------------|-------------|-------------|-------------|-----------|----------|-----------|----------|
| | SD | D | U | A | SA | NA | | | |
| UNI Teachers | 1 3.1% | 2 6.3% | 2 6.3% | 13 40.6% | 14 43.8% | 0 | 4.16 | 1.02 | 32 |
| UNI Students | 8 5.1% | 20 12.7% | 9 5.7% | 64 40.8% | 54 34.4% | 0 | 3.88 | 1.18 | 155 |
| NKNU Teachers | 1 3.3% | 3 10.0% | 3 10.0% | 13 43.3% | 9 30.0% | 1 3.3% | 3.90 | 1.08 | 29 |
| NKNU Students | 10 5.6% | 37 20.8% | 30 16.9% | 74 41.6% | 20 11.2% | 7 3.9% | 3.33 | 1.12 | 171 |

Two-Way ANOVA Summary Table

| Source | <u>df</u> | <u>MS</u> | <u>F</u> | <u>p</u> |
|-----------------|-----------|-----------|----------|----------|
| School Factor | 1 | 8.28 | 6.48 | 0.02* |
| Member Factor | 1 | 9.09 | 7.11 | 0.01* |
| School x Member | 1 | 1.04 | 0.81 | 0.37 |
| Error | 383 | 1.28 | | |
| Total | 387 | | | |

Questionnaire Item 22: Students Actively Participated
During the Class

| | Frequency and Percentage | | | | | | <u>M</u> | <u>SD</u> | <u>n</u> |
|------------------|--------------------------|-------------|-------------|-------------|-------------|-----------|----------|-----------|----------|
| | SD | D | U | A | SA | NA | | | |
| UNI Teachers | 0 | 2 6.3% | 4 12.5% | 14 43.8% | 12 37.5% | 0 | 4.12 | 0.87 | 32 |
| UNI Students | 5 3.2% | 13 8.3% | 10 6.4% | 79 50.3% | 50 31.8% | 0 | 3.99 | 1.00 | 157 |
| NKNU Teachers | 2 6.7% | 9 30.0% | 4 13.3% | 11 36.7% | 4 13.3% | 0 | 3.20 | 1.21 | 30 |
| NKNU Students | 15 8.4% | 44 24.7% | 44 24.7% | 60 33.7% | 10 5.6% | 5 2.8% | 3.03 | 1.09 | 173 |

Two-Way ANOVA Summary Table

| Source | <u>df</u> | <u>MS</u> | <u>F</u> | <u>p</u> |
|-----------------|------------|-----------|----------|----------|
| School Factor | 1 | 46.26 | 42.02 | 0.01* |
| Member Factor | 1 | 1.15 | 1.04 | 0.31 |
| School x Member | 1 | 0.02 | 0.01 | 0.91 |
| Error | 388 | 1.10 | | |
| <u>Total</u> | <u>392</u> | | | |

Questionnaire Item 23: Appropriate Pacing Was Conducted During the Class

| | Frequency and Percentage | | | | | | <u>M</u> | <u>SD</u> | <u>n</u> |
|---------------|--------------------------|-------------|-------------|--------------|-------------|----|----------|-----------|----------|
| | SD | D | U | A | SA | NA | | | |
| UNI Teachers | 0 | 4 12.5% | 2 6.3% | 15 46.9% | 11 34.4% | 0 | 4.03 | 0.97 | 32 |
| UNI Students | 7 4.5% | 19 12.1% | 24 15.3% | 81 51.6% | 26 16.6% | 0 | 3.64 | 1.04 | 157 |
| NKNU Teachers | 0 | 2 6.7% | 2 6.7% | 17 56.7% | 9 30.0% | 0 | 4.10 | 0.80 | 30 |
| NKNU Students | 0 | 15 8.5% | 26 14.7% | 109 61.6% | 27 15.3% | 0 | 3.84 | 0.78 | 177 |

Note. NKNU students had 1 missing case.

Two-Way ANOVA Summary Table

| Source | <u>df</u> | <u>MS</u> | <u>F</u> | <u>p</u> |
|-----------------|------------|-----------|----------|----------|
| School Factor | 1 | 0.94 | 1.13 | 0.29 |
| Member Factor | 1 | 5.65 | 6.84 | 0.01* |
| School x Member | 1 | 0.22 | 0.27 | 0.61 |
| Error | 392 | 0.832 | | |
| Total | 396 | | | |

Questionnaire Item 24: Communication Between/Among Sites Was Not Difficult

| | Frequency and Percentage | | | | | | <u>M</u> | <u>SD</u> | <u>n</u> |
|---------------|--------------------------|-------------|-------------|-------------|-------------|-----------|----------|-----------|----------|
| | SD | D | U | A | SA | NA | | | |
| UNI Teachers | 3 9.4% | 4 12.5% | 2 6.3% | 17 53.1% | 5 15.6% | 1 3.1% | 3.55 | 1.21 | 31 |
| UNI Students | 11 7.0% | 31 19.7% | 19 12.1% | 70 44.6% | 25 15.9% | 1 0.6% | 3.43 | 1.18 | 156 |
| NKNU Teachers | 2 6.7% | 13 43.3% | 3 10.0% | 10 33.3% | 2 6.7% | 0 | 2.90 | 1.16 | 30 |
| NKNU Students | 19 10.7% | 61 34.5% | 34 19.2% | 50 28.2% | 13 7.3% | 0 | 2.87 | 1.16 | 177 |

Note. NKNU students had 1 missing case.

Two-Way ANOVA Summary Table

| Source | <u>df</u> | <u>MS</u> | <u>F</u> | <u>p</u> |
|-----------------|-----------|-----------|----------|----------|
| School Factor | 1 | 18.79 | 13.71 | 0.01* |
| Member Factor | 1 | 0.29 | 0.21 | 0.65 |
| School x Member | 1 | 0.10 | 0.07 | 0.79 |
| Error | 390 | 1.37 | | |
| Total | 394 | | | |

Questionnaire Item 25: Classrooms/Sites Were Organized and Managed Well

| | Frequency and Percentage | | | | | | <u>M</u> | <u>SD</u> | <u>n</u> |
|---------------|--------------------------|-------------|-------------|-------------|-------------|-----------|----------|-----------|----------|
| | <u>SD</u> | <u>D</u> | <u>U</u> | <u>A</u> | <u>SA</u> | <u>NA</u> | | | |
| UNI Teachers | 0 | 4 12.5% | 9 28.1% | 14 43.8% | 5 15.6% | 0 | 3.63 | 0.91 | 32 |
| UNI Students | 6 3.8% | 17 10.8% | 15 9.6% | 84 53.5% | 33 21.0% | 2 1.3% | 3.78 | 1.03 | 155 |
| NKNU Teachers | 0 | 6 20.0% | 7 23.3% | 11 36.7% | 6 20.0% | 0 | 3.57 | 1.04 | 30 |
| NKNU Students | 5 2.8% | 46 25.8% | 54 30.0% | 59 33.1% | 9 5.1% | 5 2.8% | 3.12 | 0.96 | 173 |

Two-Way ANOVA Summary Table

| Source | <u>df</u> | <u>MS</u> | <u>F</u> | <u>p</u> |
|-----------------|------------|-----------|----------|----------|
| School Factor | 1 | 6.70 | 6.85 | 0.01* |
| Member Factor | 1 | 1.09 | 1.12 | 0.29 |
| School x Member | 1 | 4.70 | 4.80 | 0.03* |
| Error | 386 | 0.98 | | |
| Total | 390 | | | |

APPENDIX N

DESCRIPTIVE AND INFERENTIAL STATISTICAL DATA

OF EACH QUESTION OF

QUESTIONNAIRE PART III: ATTITUDES TOWARD ITV CLASSES

Note. Likert scale was used to determine the mean scores. It ranges are: SD (Strongly Disagree) = 1, D (Disagree) = 2, U (Undecided) = 3, A (Agree) = 4, SA (Strongly Agree) = 5.

NA = Not Applicable. (This value in "NA" is the same as in "N" on questionnaire)

n = Valid Frequency.

School Factors are UNI and NKNU.

Member Factors are Teachers and Students.

It is unnecessary to compare the items which "NA" percentages are under 5% in both schools.

Questionnaire Item 26: My Attitude Toward the Use of ITV
Technology for Teaching and Learning Is Positive

| | Frequency and Percentage | | | | | | <u>M</u> | <u>SD</u> | <u>n</u> |
|------------------|--------------------------|------------|------------|--------------|-------------|----|----------|-----------|----------|
| | SD | D | U | A | SA | NA | | | |
| UNI Teachers | 1 3.1% | 3 9.4% | 3 9.4% | 16 50.0% | 9 28.1% | 0 | 3.91 | 1.03 | 32 |
| UNI Students | 5 3.2% | 14 8.9% | 12 7.6% | 64 40.8% | 62 39.5% | 0 | 4.04 | 1.06 | 157 |
| NKNU Teachers | 0 | 1 3.3% | 2 6.7% | 12 40.0% | 15 50.0% | 0 | 4.37 | 0.76 | 30 |
| NKNU Students | 0 | 9 5.1% | 11 6.2% | 117 65.7% | 41 23.9% | 0 | 4.07 | 0.70 | 178 |

Two-Way ANOVA Summary Table

| Source | <u>df</u> | <u>MS</u> | <u>F</u> | <u>p</u> |
|-----------------|-----------|-----------|----------|----------|
| School Factor | 1 | 3.05 | 3.85 | 0.06 |
| Member Factor | 1 | 0.34 | 0.43 | 0.51 |
| School x Member | 1 | 2.50 | 3.15 | 0.08 |
| Error | 393 | 0.79 | | |
| Total | 397 | | | |

Questionnaire Item 27: My Attitude Toward ITV Courses in General Is Positive

| | Frequency and Percentage | | | | | | <u>M</u> | <u>SD</u> | <u>n</u> |
|---------------|--------------------------|------------|------------|--------------|-------------|----|----------|-----------|----------|
| | SD | D | U | A | SA | NA | | | |
| UNI Teachers | 1 3.1% | 4 12.5% | 3 9.4% | 15 46.9% | 9 28.1% | 0 | 3.84 | 1.08 | 32 |
| UNI Students | 3 1.9% | 15 9.6% | 8 5.1% | 73 46.5% | 58 36.9% | 0 | 4.07 | 0.99 | 157 |
| NKNU Teachers | 0 | 1 3.3% | 2 6.7% | 12 40.0% | 15 50.0% | 0 | 4.37 | 0.76 | 30 |
| NKNU Students | 0 | 10 5.6% | 14 7.9% | 121 68.0% | 33 18.5% | 0 | 3.99 | 0.70 | 178 |

Two-Way ANOVA Summary Table

| Source | <u>df</u> | <u>MS</u> | <u>F</u> | <u>p</u> |
|-----------------|-----------|-----------|----------|----------|
| School Factor | 1 | 2.61 | 3.51 | 0.06 |
| Member Factor | 1 | 0.28 | 0.37 | 0.54 |
| School x Member | 1 | 4.68 | 6.29 | 0.02* |
| Error | 393 | 0.74 | | |
| Total | 397 | | | |

Questionnaire Item 28: I Felt Comfortable With the ITV
Classes

| | Frequency and Percentage | | | | | | <u>M</u> | <u>SD</u> | <u>n</u> |
|------------------|--------------------------|------------|-------------|-------------|-------------|----|----------|-----------|----------|
| | SD | D | U | A | SA | NA | | | |
| UNI Teachers | 1 3.1% | 3 9.4% | 1 3.1% | 17 53.1% | 10 31.3% | 0 | 4.00 | 1.02 | 32 |
| UNI Students | 3 1.9% | 13 8.3% | 8 5.1% | 73 46.5% | 60 38.2% | 0 | 4.11 | 0.97 | 157 |
| NKNU Teachers | 0 | 5 16.7% | 3 10.0% | 13 43.3% | 9 30.0% | 0 | 3.87 | 1.04 | 30 |
| NKNU Students | 4 2.3% | 11 6.2% | 25 14.1% | 97 54.8% | 40 22.6% | 0 | 3.89 | 0.90 | 177 |

Note. NKNU students had 1 missing case.

Two-Way ANOVA Summary Table

| Source | <u>df</u> | <u>MS</u> | <u>F</u> | <u>p</u> |
|-----------------|-----------|-----------|----------|----------|
| School Factor | 1 | 1.59 | 1.77 | 0.18 |
| Member Factor | 1 | 0.24 | 0.26 | 0.61 |
| School x Member | 1 | 0.09 | 0.10 | 0.75 |
| Error | 392 | 0.90 | | |
| Total | 396 | | | |

Questionnaire Item 29: I Am Satisfied With ITV Instruction

| | Frequency and Percentage | | | | | | <u>M</u> | <u>SD</u> | <u>n</u> |
|---------------|--------------------------|-------------|-------------|--------------|-------------|----|----------|-----------|----------|
| | SD | D | U | A | SA | NA | | | |
| UNI Teachers | 1 3.1% | 4 12.5% | 8 25.0% | 14 43.8% | 5 15.6% | 0 | 3.56 | 1.01 | 32 |
| UNI Students | 3 1.9% | 17 10.8% | 12 7.6% | 67 42.7% | 58 36.9% | 0 | 4.02 | 1.03 | 157 |
| NKNU Teachers | 0 | 7 23.3% | 2 6.7% | 13 43.3% | 8 26.7% | 0 | 3.73 | 1.11 | 30 |
| NKNU Students | 3 1.7% | 12 6.7% | 36 20.2% | 100 56.2% | 27 15.2% | 0 | 3.76 | 0.85 | 178 |

Two-Way ANOVA Summary Table

| Source | <u>df</u> | <u>MS</u> | <u>F</u> | <u>p</u> |
|-----------------|-----------|-----------|----------|----------|
| School Factor | 1 | 0.09 | 0.10 | 0.75 |
| Member Factor | 1 | 3.10 | 3.39 | 0.07 |
| School x Member | 1 | 2.37 | 2.58 | 0.11 |
| Error | 393 | 0.92 | | |
| Total | 397 | | | |

APPENDIX O

ONE THING THAT
YOU LIKE BEST ABOUT ITV CLASSES

UNI ITV Teachers' Preferences (32 Teachers)

The modal response (six persons) of UNI ITV teachers was that the convenience was one thing that they liked best about ITV classes. The other responses were as follows:

1. It enables people from a distance to have access to courses.
2. It really got me organized.
3. The ability to reach students who otherwise would not have been able to take the class or would not be able in graduate school.
4. Made instruction accessible to many more students.
5. Taught me how to incorporate better and different forms of media into my instruction.
6. The overhead camera makes transparencies unnecessary.
7. Could reach students at remote sites.
8. People do not have to travel a long distance to attend class.
9. Can interact with students.
10. Can have contact with high school teachers in ITV classrooms.

UNI ITV Students' Preferences (145 Students)

The modal response (35 persons) of UNI ITV students was that having not to travel a long distance for class was one thing that they liked best about ITV classes. The other responses were reported as follows:

1. Convenience to have the class closer to my home/work.

2. It allows people in remote locations (off UNI campus) to take advantage of courses and work toward a degree.
3. Have a variety of courses.
4. Highly structured instruction.
5. Meeting and interacting with remote site classmates from another part of the state.
6. Interactivity much better than video only.
7. The site discussions and the sharing between sites.
8. It was easy to make up if you were absent.

NKNU ITV Teachers' Preferences (27 Teachers)

The modal response (six persons) of NKNU ITV teachers was that discussion with many different university students at the same time was one thing that they like best about ITV classes. The other responses were as follows:

1. Instructor can immediately understand the situation of students at different sites.
2. Instructor can interact with many different university students at the same time.
3. The material can be presented clearly and immediately.
4. Instructor can use computer multimedia to help in teaching.
5. Many different university students can use the resources together.
6. It offered a new way of teaching.
7. To compare the behaviors of different university students.

NKNU ITV Students' Preferences (124 Students)

The modal response (37 persons) of NKNU ITV students was that interaction with another university students was one thing that they like best about the ITV classes. The other responses were as follows:

1. Instructor uses multimedia to teach.
2. Students can take the other university teacher's course and learn a lot.
3. Students can discuss with many remote site classmates of different universities.
4. Easy, comfortable, no nervousness, and no stress.
5. Students can interact with teacher in distance location.
6. Watching film (movie) or Internet information.
7. Smoothly teaching and no system breakdown.
8. Students can grasp the teaching point clearly.
9. Screen image can be seen clearly.
10. No face-to-face pressure.

APPENDIX P

ONE THING THAT
YOU DISLIKE MOST ABOUT ITV CLASSES

UNI ITV Teachers' Dislikes (32 Teachers)

The modal responses (six persons) of UNI ITV teachers was that technology and system breakdown was one thing that they disliked most. Other negative responses were as following:

1. The difficulty in having dynamic discussion.
2. Technical problems.
3. The lack of opportunity to interact person to person.
4. When equipment did not work.
5. Having to operate the controls.
6. Not being able to see the students on the screen clearly.
7. One cannot effectively put things on reserve or require much in the way of library research.
8. Testing.
9. My students had a difficult time finding resources to use.
10. Difficulty to do in-class activities.
11. Cannot build relationship with students.
12. Cannot move around when teaching.
13. Hard to see students' eyes for feedback.
14. Lack of good technical assistance.
15. All remote sites are not equally furnished or equipped.
16. Not being able do see all sites at the same time.

17. Contact with students is too limited with multiple sites.
18. You do not get to know the students.

UNI ITV Students' Dislikes (141 Students)

The modal response (28 persons) of UNI ITV students was that technology failure was one thing that they disliked most. The other responses were as follows:

1. When the technology fails (i.e., black outs, sound outs, inability to send signal from remote site to instructor.
2. When the sound is awful or something is not working right.
3. Frequent technical problems and equipment failure.
4. One class had too many student presentations.
5. The absence of personal contact with the instructor.
6. Talking on the microphone.
7. Once the session is over, it's over. There is no interaction with instructor after class.
8. Unfamiliarity with equipment made presentation difficult.
9. Not comfortable talking on camera.
10. Inability to interact in a natural way. It is hard to ask questions.
11. None really.
12. You can not catch the professor before or after class with quick questions.

13. Sometimes it is hard to participate vocally due to size of class.
14. Can't always get teacher's attention.
15. Feedback on assignments was slow.
16. Building a rapport with fellow classmates is more difficult.
17. I would hate to be at a site by myself. I was all alone in my room.
18. Communication with instructors is not as good as it is in a regular classroom setting.
19. Not all sites have the equipment necessary for presentations.
20. Sometimes certain sites including those with the professor get into conversations, but do not press the microphone. We miss the information.
21. Technical problems.
22. Lack of personal contact.
23. Hard to interact with others.
24. Difficult to actively participate in discussion.
25. Very hard to get a variety of activities and inability to do group work during class.
26. Pushing a button and speaking into a microphone.
27. System jams up when everyone tries to talk at once.
28. Lack of personal relations with classmates at other sites.
29. The research from distance site is difficult.
30. Far away from university library, difficult to find materials online, made research hard.

NKNU ITV Teachers' Dislikes (26 Teachers)

The modal response (seven persons) of NKNU ITV teachers was that system breakdown was one thing that they disliked most. The other responses were as follows:

1. Equipment breakdown, system problems, no sound, and no graphic interrupted the teaching.
2. Can not know the student attendance or absence.
3. Too many students, and too many sites, the interaction and discussion are not easy.
4. More difficult to make personal contact.
5. Can not see students on the screen clearly.
6. Not really.
7. Face to the screen, feel monotonous.
8. Communication with students is not easy.

NKNU ITV Students' Dislikes (113 Students)

The modal response (51 persons) of NKNU ITV students was that system breakdown was one thing that they disliked most. The other responses were as follows:

1. Technical problem.
2. Can not get the answer for my question after class.
3. No discuss.
4. Can not receive the hand out in a timely fashion.
5. System breakdown.
6. Worry about to be shown on the screen any time.

7. Words are very small on the screen to watch, make my eyes tired.
8. To be called to answer question and shown on the screen.
9. Discipline is not good.
10. System Breakdown and delay the schedule.
11. Sound noise and image are not clear.
12. Interaction is not frequent.
13. No organization.
14. Communication is difficult between students and instructor.
15. Sometimes instructor looks like a talking head and this was very boring.

APPENDIX Q

COMMENTS ABOUT ITV CLASSES

UNI ITV Teachers' Comments (15 Teachers)

There were 15 teachers made comments. The comments were reported as follows:

1. I wish the technology would allow the instructor to hear all sites at once as well as by site.
2. There were limitations to what one can do or accomplish.
3. It was excellent way to reach public school teachers in rural communities.
4. Limit the reception sites to 3 plus origination site.
5. Having one student at a remote site is not a good situation; and 3 should be the minimum.
6. I feel the instructor has to reduce the quantity and depth of material covered to fit this format.
7. Personal contact is important.
8. Support personnel might be considered.
9. Excellent way to reach public school teachers in rural communities.
10. It is still awkward to pre-balance audio music transmission from an electric keyboard and CD player.
11. When origination site has a larger number of students than other sites, the remote sites are much harder to integrate into the class.
12. I really like it.

UNI ITV Students' Comments (80 Students)

There were 80 samples (51%) responded written comments. The comments were as follows:

1. Instructors make the difference in the experience when they allow interaction and decrease lecture.
2. Too much talking by instructor.
3. To equip the standard equipment look like the origination site.
4. A newer or improved rapid response system (such as the commercial networks use on talk shows) should be used so more than one person can talk at one time.
5. Our class met with no one on the site ever to help us or even introduce the equipment and how to operate it.
6. It was extremely frustrating to never receive my written papers back--there was absolutely no feedback.
7. Very impersonal.
8. Teachers must be very organized to counteract the impersonal nature of ITV.
9. I want an instructor on site that I can discuss things with, ask questions, and get to know.
10. I wish it was possible for the professor to visit the sites.
11. Reduce and limit class size.
12. The more classes offered, the better.
13. It is a wonderful program.
14. Knowing how to use the technology effectively is important to the success of these courses.

15. When the technology works, it is good, but when the technology has problems it is so frustrating and there are no alternatives to replace it in a timely way.
16. I would not be able to pursue MA degree if I had to drive to UNI for all of the classes.
17. Teachers need much more profession development relate to ITV pedagogy.
18. I need ITV classes.

NKNU ITV Teachers' Comments (18 Teachers)

Eighteen teachers (60%) made the following comments:

1. Enhance equipment, technology, and technician technique.
2. ITV classes can be developed.
3. Limit the student number.
4. Every site needs an assistant teacher.
5. Student can hand in the assignment by e-mail.
6. One should consider the course sort to fit ITV.
7. If the techniques and equipment are enhanced, the practices will be better.
8. Teacher should visit remote sites and contact with students.
9. Need to enhance test method.

NKNU ITV Students' Comments (42 Students)

Forty-two NKNU students (23.6%) made the following comments:

1. Instructor needs devote more attention to remote site student learning.
2. Enhance the technology and communication system.
3. Handouts need to be received before class.
4. Instructor needs to be familiar with the technology operation.
5. Instructor needs to use more graphics (not words) or films to enhance teaching.
6. Limit the site size.
7. Offering more classes of ITV program.
8. Site needs teaching assistance.
9. Enhance the discussion with the remote site.

APPENDIX R

TITLES OF UNI ITV COURSES
OFFERED BEFORE SPRING SEMESTER 2000

1. Adaptations
2. Analytical techniques I
3. Bilingual Education
4. Change and Transformation
5. Child, Family, School in Community Relations

6. Collaborative Consultation
7. Community Resources
8. Constructionist Early Education
9. Coordinating Programs for the Gifted and Talented
10. Directing the Safety program

11. Driver and Traffic Safety
12. Early Childhood Special Education Courses
13. Educational Leadership
14. Educational Research
15. Educational Strategies for the Talented and Gifted

16. Elementary Math and Science Curriculum
17. Festivals and Special Events Management
18. Foundations of Instructional Psychology
19. Foundation of Music Education
20. Home Intervention Services to Infant/Toddler

21. Instruction to Superintendency
22. Industrial Safety
23. Integrated Marketing Communications
24. Interpersonal Communication
25. Introduction to Graduate Studies

26. Issues and Problems in Teaching Middle Grades Math
27. Issues and Trends in Middle Level Curriculum
28. Language and Communication
29. Language Arts Across the Curriculum
30. Library Materials for Young Adults

31. Mathematics for Middle Grades Teachers I
32. Media Planning and Production
33. Music Learning and Behavior
34. Organizational Management
35. Organizational Psychology

36. Organizational Studies
37. Problems in English Grammar
38. Psychology of Adolescence
39. School Finance
40. School Governance, Law and Inter-systems Relations

41. School Library Media Curriculum Development
42. School Music Administration
43. School Personnel Management
44. Seminar in Communication Education: Distance learning
45. Seminar in Performance Studies

46. Seminar in Public Relationship Contemporary Practice and Issues
47. Studies in Bilingual Education in the Public Schools
48. Studies Performance of Literature
49. Survey of Music Theory
50. Teaching and Learning Models in Science Education

51. Teaching Elementary School Social Studies
52. Teaching-Learning Models in Science Education
53. Telecommunications in Education
54. The History and Philosophy of Science
55. Theory Survey for Graduate Students

56. Traffic Law Enforcement
57. Work-site Health Promotion
58. World of Technology
59. Young Adult Literature

APPENDIX S

TITLES OF NKNU ITV COURSES
OFFERED BEFORE SPRING SEMESTER 2000

1. Adult Psychology
2. Affection, Intention, and Love
3. Analysis of Current Domestic and International Affairs
4. Bio-ethics
5. Career Planning
6. Community Development

7. Constructing the Beautiful Planet
8. Crisis Assistance
9. Economics and Living
10. Effective Learning Strategies
11. Emotion Quality
12. English teaching Aids and Media

13. Environment and Living
14. Food Nutrition and Health
15. Gender Culture and Society
16. Gender Relationship
17. Health Planning
18. Health Psychology

19. History of Taiwan's Development
20. Introduction to Chinese Medical Science
21. Instruction to Computer
22. Introduction to Music
23. Instruction to Special Education
24. Internet and World Wide Web

25. Knowing Cosmos
26. Knowing the Medicines
27. Knowing the Nature Medicines
28. Law and Life
29. Living Psychology
30. Marriage and Family

31. Network and Living
32. Oral Cavity Health
33. Personal Relationship and Communication
34. Technology and Education
35. Technology and Humanity
36. Technology and Society

APPENDIX T

A BRIEF LIST OF
SIMILARITIES AND DIFFERENCES
BETWEEN UNI AND NKNU ITV PROGRAMS

ITV Teaching Methods

Similarities

1. Table 5
Q08, Q10, Q13, Q16. ----- "Not Used"
2. Table 6
Q02, Q14. -----Highly Agree
3. Table 6
Q03, Q05, Q06, Q08,
Q09, Q12, Q13, Q17, Q18. ----- Moderately Agree
4. Table 6
Q07, Q15, Q16. -----Weakly Agree

Differences

5. Table 5
Q07, Q09, Q15. ----- "Not Used" Percentages UNI > NKNU
6. Table 5
Q03, Q11, Q18. -----"Not Used" Percentages NKNU > UNI
7. Table 7
Q04 (UNI Moderately Agree) > (NKNU Moderately Agree)
Q10 (UNI Moderately Agree) > (NKNU Weakly Agree)
Q11 (UNI Moderately Agree) > (NKNU Weakly Disagree)

Classroom Management

Similarities

8. Table 6
Q19, Q20, Q23. ----- Moderately Agree

Differences

9. Table 7
Q21 (UNI Moderately Agree) > (NKNU Weakly Agree)
Q22 (UNI Highly Agree) > (NKNU Weakly Agree)
Q25 (UNI Moderately Agree) > (NKNU Weakly Agree)
10. Table 7
Q24 (UNI Weakly Agree) > (NKNU Weakly Disagree)

Attitudes Toward ITV Class

Similarities

11. Table 6
 Q26, Q27. ----- Highly Agree
 Q28, Q29. ----- Moderately Agree

Differences

(No)

Demographics

Teacher Section

Similarities

12. Table 8
 Item 1, the modal response was Male.
 Item 5, the modal response was 1 course.
 Item 7, the modal response was 5 sites.

Differences

13. Table 8
 Item 1, UNI percentage was larger than NKNU on Female
 Item 2, UNI percentage was larger than NKNU on Over 45 years of age.
 Item 3, UNI percentage was larger than NKNU on Over 20 years.
 Item 4, UNI percentage was larger than NKNU on Over 2 years.
 Item 5, UNI percentage was larger than NKNU on 5 or more courses
 Item 6, UNI percentage was larger than NKNU on Attended training.
 Item 7, UNI percentage was larger than NKNU on 5 or more sites.

Student Section

Similarities

(No)

Differences

14. Table 9
 Item 1, UNI percentage was larger than NKNU on Female
 Item 2, UNI percentage was larger than NKNU on Part-time Graduate.
 Item 3, UNI percentage was larger than NKNU on Over 23 years of age.
 Item 4, UNI percentage was larger than NKNU on 3 or more courses.